

**Town of Ringle**  
**Marathon County, Wisconsin**

**ZONING ORDINANCE**



# Table of Contents

- Section 1 Title, Authority and General Provisions..... 1**
  - 1.01 Title
  - 1.02 Authority
  - 1.03 Effective Date
  - 1.04 Contents
  - 1.05 Purpose
  - 1.06 Applicability and Compliance
  - 1.07 Abrogation and Greater Restrictions
  - 1.08 Interpretation
  - 1.09 Severability
  - 1.10 Repeal
  
- Section 2 Zoning Districts, Zoning Map, and Use Regulations..... 4**
  - 2.01 Zoning Districts
  - 2.02 Zoning Map
  - 2.03 Purpose and Intent of Zoning Districts
  - 2.04 Types of Uses
  - 2.05 Principal Uses
  - 2.06 Accessory Uses
  - 2.07 Temporary Uses and Structures
  - 2.08 Uses Not Listed
  
- Section 3 Additional Use Requirements..... 11**
  - 3.01 Purpose
  - 3.02 Applicability
  - 3.03 Agricultural Uses
  - 3.04 Recreational Uses
  - 3.05 Residential Uses
  - 3.06 Commercial Uses
  - 3.07 Institutional Uses
  - 3.08 Industrial Uses
  - 3.09 Miscellaneous Uses
  
- Section 4 General Requirements..... 21**
  - 4.01 Compliance
  - 4.02 District Requirements
  - 4.03 Lot Requirements
  - 4.04 Setbacks from Roads
  - 4.05 Height Requirements
  - 4.06 Front, Rear, and Side Yards
  - 4.07 Floor Area Requirements
  - 4.08 Accessory Structures

<b>Section 5</b>	<b>Parking, Loading, and Access/Driveway Requirements.....</b>	<b>32</b>
5.01	Purpose and Applicability	
5.02	Off-Street Parking Requirements	
5.03	Loading Requirements	
5.04	Access/Driveway Requirements	
<b>Section 6</b>	<b>Supplemental Requirements.....</b>	<b>39</b>
6.01	Town Roads	
6.02	Outdoor Storage of Junk, Certain Vehicles and Recreational Equipment	
6.03	Firearms, Weapons, and Bow Hunting	
<b>Section 7</b>	<b>Signs.....</b>	<b>48</b>
7.01	Purpose	
7.02	Intent	
7.03	Authorization	
7.04	Compliance and Permit Required	
7.05	General Requirements	
7.06	Sign Permit	
7.07	Exemptions	
7.08	Standards	
7.09	Signs Permitted in Agricultural/Forestry (AG/F), Recreational (REC), Concentrated Mixed Use (CMU), General Commercial (GC) and Intensive/Light Industrial (IC/LI) Districts	
7.10	Signs Permitted in Residential-Large Lot (R-1) and Residential-Small Lot (R-2) Districts	
7.11	Election Campaign Signs	
7.12	Nonconforming Signs	
7.13	Sign Definitions	
<b>Section 8</b>	<b>Mobile Tower Siting Regulations.....</b>	<b>63</b>
8.01	Purpose	
8.02	Definitions in this Section	
8.03	Siting and Construction of any New Mobile Service Support Structure and Facilities	
8.04	Class 1 Collocation	
8.05	Class 2 Collocation	
8.06	Requirements	
8.07	Appeal	
8.08	Severability	

<b>Section 9</b>	<b>Nonconforming</b> .....	<b>72</b>
9.01	Applicability	
9.02	Purpose	
9.03	Authority to Continue	
9.04	Repairs and Maintenance	
9.05	Nonconforming Uses	
9.06	Nonconforming Structures	
9.07	Nonconforming Lots	
<b>Section 10</b>	<b>Administration</b> .....	<b>74</b>
10.01	Organization	
10.02	Building Inspector/Zoning Administrator	
10.03	Town Planning and Zoning Committee	
10.04	Board of Appeals	
<b>Section 11</b>	<b>Procedures and Enforcement</b> .....	<b>79</b>
11.01	Zoning Permits	
11.02	Occupancy Certificates	
11.03	Conditional Use Permits	
11.04	Sign Permits	
11.05	Wrecking Permits	
11.06	Amendments	
11.07	Variances	
11.08	Appeals	
11.09	Public Hearings	
11.10	Fee Schedule	
11.11	Penalties	
<b>Section 12</b>	<b>Definitions</b> .....	<b>98</b>
12.01	Definitions	
12.02	Words and Phrases Defined	

## **SECTION 1 TITLE, AUTHORITY AND GENERAL PROVISIONS**

- 1.01 TITLE.** This Ordinance shall be known as the “Town of Ringle Zoning Ordinance”, hereinafter referred to as “this Ordinance”.
- 1.02 AUTHORITY.** These regulations are adopted under the authority granted by Chapters 60.62, 61.35, and 62.23(7), Wis. Stats.
- 1.03 EFFECTIVE DATE** This Ordinance shall be effective following adoption by the Town of Ringle Board of Supervisors and Marathon County Board of Supervisors.
- 1.04 CONTENTS.** This Ordinance consists of two distinct but inseparable and integrated parts: written text and the zoning map. The written text and zoning map taken together constitute this Ordinance and, therefore, shall at all times be considered as interrelated and inseparable parts of a whole. In addition, other maps and materials referenced in the text are used to support this Ordinance.
- 1.05 PURPOSE.** The purposes of this Ordinance include:
- (1) To promote and protect the public health, safety, convenience, and general welfare;
  - (2) To promote planned and orderly land use development;
  - (3) To separate incompatible land uses and foster a more rational pattern of relationship between land uses for the mutual benefit of all
  - (4) To protect property values, tax base and public and private investments;
  - (5) Prevent the overcrowding of land and the congestion of streets by enforcing regulations that protect the traffic-carrying capacity, safety, and efficiency of all existing and future town, county, and state roadways;
  - (6) To provide public services and infrastructure in an economical and efficient manner;
  - (7) To provide adequate standards of light, air, and open space;
  - (8) Secure safety from fire, flooding, pollution, contamination, panic, and other dangers;
  - (9) Avoid undue concentration of population;
  - (10) To protect community resources such as farmland, woodlands, groundwater, surface water, and historic and cultural resources.

## **1.06 APPLICABILITY AND COMPLIANCE.**

- (1) **APPLICABILITY.** This Ordinance, unless otherwise provided herein, is applicable to and effective within the Town of Ringle.
- (2) **COMPLIANCE.**
  - (a) Unless otherwise provided by this Ordinance, after the effective date of this Ordinance, no land or water shall hereafter be used and no structure or part thereof shall hereafter be used, located, erected, moved, reconstructed, extended, enlarged, converted, or structurally altered without full compliance with the provisions of this Ordinance.
  - (b) Unless specifically exempted by law, all cities, villages, towns, and counties are required to comply with this Ordinance and obtain all necessary permits in areas under the jurisdiction of this Ordinance.

Construction undertaken by the State of Wisconsin is, pursuant to § 30.12(4), Wis. Stats., subject to this Ordinance. This includes every building, structure, or facility that is constructed for the benefit of or use of the State of Wisconsin.

- (c) The Town Board or owner(s) of property within the town who are affected by a particular regulation, variance or conditional use under this Ordinance may sue to enforce, by injunctive order, compliance with this Ordinance.

## **1.07 ABROGATION AND GREATER RESTRICTIONS**

- (1) The previous Town of Ringle Zoning Ordinance, originally dated March 3, 1975, is hereby repealed on the date in which this Ordinance becomes effective.
- (2) It is not the intent of this Ordinance to repeal, abrogate, annul, impair, or interfere with any existing easement, covenant, deed restriction, or agreement, ordinances, rules, regulations, or permits previously adopted or issued pursuant to laws. However, wherever this Ordinance imposes greater restrictions, the provisions of this Ordinance shall govern.

The Town of Ringle shall not enforce any easement, covenant, deed restriction, or agreement to which it is not a party. Enforcement of any such covenant, deed, easement, or restriction via the Town's zoning authority would constitute an impermissible delegation of the Town's authority and power.

- (3) It is not intended by this Ordinance to repeal, abrogate, annul, impair, or interfere with any permit previously issued pursuant to law.

- 1.08 INTERPRETATION** In the interpretation and application, the provisions of this Ordinance shall be held to be minimum requirements and shall be liberally construed in favor of the Town and shall not be deemed a limitation or repeal of any other power granted by Wisconsin Statutes.
- 1.09 SEVERABILITY** If any section, paragraph, clause, provision, or portion of this Ordinance is adjudged unconstitutional or invalid by a court of competent jurisdiction, the remainder of this Ordinance shall not be affected thereby.
- 1.10 REPEAL** All other ordinances or parts of ordinances of the Town inconsistent or conflicting with this Ordinance, to the extent of the inconsistency only, are hereby repealed.

## **SECTION 2 ZONING DISTRICTS, ZONING MAP, AND USE REGULATIONS**

**2.01 ZONING DISTRICTS.** For the purpose of this Ordinance, the lands of the Town of Ringle are hereby divided into the following zoning districts:

Agricultural/Forestry District (AG/F)  
Recreational District (REC)  
Residential-Large Lot District (R-1)  
Residential-Small Lot District (R-2)  
Concentrated Mixed Use District (CMU)  
General Commercial District (GC)  
Intensive Commercial/Light Industrial District (IC/LI)

**2.02 ZONING MAP.**

(1) The location and boundaries of the districts established shall be as shown on the map entitled “Town of Ringle Zoning Map, Marathon County, Wisconsin”. The Zoning Map with all notations, dimensions, designations, references and other data shall accompany and is part of this Ordinance. Amendments to the Official Zoning Map are described in Section 11 of this Ordinance.

(2) **INTERPRETATION OF ZONING DISTRICT BOUNDARIES.**

Where uncertainty exists as to the boundaries of districts as shown on the official Zoning Map, the following rules shall apply:

- (a) Boundaries indicated as approximately following the center lines of streets, streams, and highways shall be construed to follow such center lines.
- (b) Boundaries indicated as approximately following platted lot lines shall be construed as following such lot lines.
- (c) Where boundaries do not follow property lines and distances are not specified on the Zoning Map, boundaries shall be determined by the use of an engineers scale on the Zoning Map.
- (d) Legal descriptions of property, when available, shall be controlling as to the zoning of any property, or the property proposed to be rezoned in accordance with the terms of the ordinance.



**2.03 PURPOSE AND INTENT OF ZONING DISTRICTS.** The following specifies the purpose and intent of each of the zoning districts established by this Ordinance.

- (1) **AGRICULTURAL/FORESTRY DISTRICT (AG/F):** This district is intended to establish and preserve areas for agricultural, agricultural-related, low-density residential, and outdoor recreation uses without permitting an intensity of development which would require the provision of urbanized facilities and services. It is also intended to accommodate certain nonagricultural uses which require spacious areas to operate or where natural resource exploitation occurs. Minimum lot sizes of 1 acre are required.
- (2) **RECREATIONAL DISTRICT (REC):** This district is also intended to provide designated areas in the Town where the enhancement and preservation of significant natural resource areas will be maintained. This district is intended to provide for the orderly and attractive grouping of natural resource-based recreational oriented establishments, facilities, and structures.
- (3) **RESIDENTIAL-LARGE LOT DISTRICT (R-1):** This district is intended to provide primarily for single and two family residential development at moderate density. Some nonresidential uses which generally do not conflict with single and two family residential uses are allowed. Minimum lot sizes of 40,000 square feet are required.
- (4) **RESIDENTIAL-SMALL LOT DISTRICT (R-2):** This district is intended to provide primarily for single family residential development at fairly high density. Some nonresidential uses which generally do not conflict with single family residential uses are allowed. Minimum lot sizes of 20,000 square feet are required.
- (5) **CONCENTRATED MIXED USE DISTRICT (CMU):** Due to existing small lot configurations and unique buildings, this district provides for a wide range of mixed uses. The intent of this district is to create compatible and creative mixed land use arrangements that are unique in comparison to other areas of the town. Minimum lot sizes of 6,000 square feet are required.
- (6) **GENERAL COMMERCIAL DISTRICT (GC):** This district is intended to provide primarily for a wide range of low to moderate intensity commercial and multi-family (3+ dwelling units) development at a moderate density. Minimum lot sizes of 1 acre are required.
- (7) **INTENSIVE COMMERCIAL/LIGHT INDUSTRIAL DISTRICT (IC/LI):** This district is intended to provide for large-scale and high intensity commercial development, and for manufacturing, warehousing, and other light industrial operations. Minimum lot sizes of 1 acre are required.

**2.04 TYPES OF USES.**

- (1) **PRINCIPAL USES.** Principal uses are sorted and assigned to specific zoning districts. (See Sec. 2.05, Principal Uses.) Such uses shall be established only if they are located in the zoning district to which they are assigned. These uses are further divided into the following two categories:
  - (a) Permitted uses. These uses are permitted by right, provided all requirements of this Ordinance are met.
  - (b) Conditional uses. These uses will be allowed, and a conditional use permit will be granted, if the applicant demonstrates, by substantial evidence, that the application and all requirements and conditions established by the town as specified in this Ordinance or imposed by the Town Board of Supervisors are or will be satisfied. See also Sec. 11.03, Conditional Use Permits.
- (2) **ACCESSORY USES.** (See Sec. 2.06, Accessory Uses.)
- (3) **TEMPORARY USES.** (See Sec. 2.07, Temporary Uses.)
- (4) **USES NOT LISTED.** (See Sec. 2.08, Uses Not Listed.)

**2.05 PRINCIPAL USES.**

- (1) The principal uses allowed in each zoning district shall be as shown in sub.(3), Table of Principal Uses.
- (2) **HOW TO USE THE TABLE OF PRINCIPAL USES.**

**Figure 2-1: How to Use Table of Principal Uses**

Zoning Districts

Type of Use	AG/F	REC	R-1	R-2	CMU	GC	IC/UI	Notes:
<b>AGRICULTURAL USES</b>								
Agriculture	P	P	P	P	P			See Sec. 3.03(1)
Agricultural-Related Use	C	C						
On-Site Agricultural Retail	C	C						
Roadside Stand	P	P						
Community Garden	P	C	C	C	C			

**KEY:**

P = Permitted uses  
 C = Conditional uses

Space without symbol means the use is not allowed.

Refer to listed section for requirements applicable to specified use.

(3) TABLE OF PRINCIPAL USES

Type of Use	AG/F	REC	R-1	R-2	CMU	GC	IC/LI	Notes:
<b>AGRICULTURAL USES</b>								
Agriculture	P	P	P	P	P			See Sec. 3.03(1)
Agricultural-Related Use	C	C						
On-Site Agricultural Retail	C	C						
Roadside Stand	P	P						
Community Garden	P	C	C	C	C			
<b>RECREATIONAL USES</b>								
Campground	C	C						
Camping	P	P	P					See Sec. 3.04(1)
Recreation Camp	C	C						
Passive Outdoor Public Recreation	P	P	P	P	P	P		
Active Outdoor Public Recreation	C	C	C	C	C	C		
Outdoor Commercial Recreation	C	C			C	C		
Commercial Riding Stable	C	C						
Outdoor Shooting Range	C	C						
<b>RESIDENTIAL USES</b>								
Single Family Detached Residence	p <sup>1</sup>	p <sup>1</sup>	P	P	P			
Two-Family Residence (Duplex) <sup>2</sup>	C <sup>1</sup>		C					
Multi-Family Residence (3+ Units)					C	C		See Sec. 3.05(1)
Accessory Dwelling Unit	P	P	P	C	C			See Sec. 3.05(2)
Manufactured Home Community				C				See Sec. 3.05(3)
Manufactured/Mobile Home				P				See Sec. 3.05(3)
Short Term Rentals	C	C	C	C	C			See Sec. 3.05(4)
Boardinghouse					C	C		
Accessory Residence					P	P	P	See Sec. 3.05(5)
<b>COMMERCIAL USES</b>								
Hotel/Motel					C	C	C	
Artisan Gallery/Studio	C				C	P	P	
Retail					C	P	P	
Professional Office/Service Establishment					C	P		
Winery/Brewery/Distillery					C	C	C	
Bakery					C	P		
Family Day Care Home	P	P	P	P	P			
Group Day Care Center					C	P		
Vehicle Sales/Service					C	C		
Gas Station/Carwash					C	P	C	
Indoor Commercial Entertainment Facility (e.g., restaurant, tavern, wedding/concert venue, etc.)					C	C	C	
Special Event Venue (e.g., wedding barn, concert venue, etc.)	C	C						See Sec. 3.06(2)
Outdoor Theater	C					C	C	
Contractor Storage Yard	C					C	P	
Kennel, Type I	P	P	P	P	P	P	P	
Kennel, Type II	C				C	C	C	

(3) TABLE OF PRINCIPAL USES (Continued...)

Type of Use	AG/F	REC	R-1	R-2	CMU	GC	IC/LI	Notes:
<b>COMMERCIAL USES (Continued)</b>								
Commercial Storage Facility					C	C	C	
Commercial Radio/TV Broadcast Studio	C	C	C	C	C	C	C	
Adult Entertainment/Adult-Oriented Establishment							C	See Sec. 3.06(3)
Commercial Trucking Establishment					C	C	C	
Lumber/Building Supply Yard						C	C	
Passenger Bus Terminal						C	C	
Home Occupation-Major	C	C	C	C	C			See Sec. 3.06(1)(b)
Home Occupation-Minor	P	P	P	P	P			See Sec. 3.06(1)(a)
<b>INSTITUTIONAL USES</b>								
Places of Worship	P	P	P	P	C	P	C	
Cemetery	P	P	P	P				
School/College/University	C		C	C	C	C	C	
Public/Private Park	P	P	P	P	P	P	P	
Municipal Building	P	P	C		P	P	P	
Social Clubs/Lodges		C			C	P	P	
Funeral Home					C	P		
Institutional Residential	C				C	C		
Community Living Arrangement	C		C	C	C			
Library/Museum					C	C		
<b>INDUSTRIAL USES</b>								
Asphalt/Concrete Plant	C						C	
Temporary Concrete/Asphalt Plant	C	C				C	C	
Nonmetallic Mining	C						C	See Sec. 3.08(1)
Solid Waste Facility (e.g., Landfill)	C	C					C	
Bulk Storage of Fuel Products							C	
Manufacturing, Assembly, Processing						C	C	
Salvage Yard	C						C	
Wastewater Treatment Plant	C	C					C	
Slaughterhouse						C	C	
Warehouse							C	
<b>MISCELLANEOUS USES</b>								
Airports	C						C	
Private Airstrips/Landing Fields	C	C						
Animal Shelters/Pounds	C					C	C	
Utility Installation-Major	C	C	C	C	C	C	C	
Utility Installation-Minor	P	P	P	P	P	P	P	
Mobile Communication Tower	C/P	C/P	C/P	C/P	C/P	C/P	C/P	See Sec. 8

FOOTNOTES:

1. Only allowed on lots/parcels which are not part of a major subdivision (i.e., County, State, Condominium, Planned Unit Development, or Conservation Plat) recorded after the effective date of this Ordinance.

**2.06 ACCESSORY USES.** Accessory uses are permitted in all zoning districts. For accessory uses involving structures or buildings, such structures or buildings shall be subject to the requirements of Sec. 4.08, accessory structures.

**2.07 TEMPORARY USES AND STRUCTURES.**

- (1) Uses and structures which are conducted or placed on a lot for not more than 10 days total, including not more than 7 consecutive days, in a calendar year and which involves the assembly of 100 or less individuals at any one time shall be known as temporary uses/structures and may be conducted or placed in any zoning district. All temporary uses and structures conducted or placed on a lot within a calendar year count toward the allowed number of days. Uses or structures which are conducted or placed for more than the allowed number of days or involve the assembly of more than 100 individuals at any one time shall be regarded as principal or accessory uses or structures and regulated accordingly.
- (2) Uses and structures which are directly associated with and incidental to a permitted construction project may be conducted or placed on a lot for more than the allowed number of days per sub. (1) above and shall be considered a temporary use or structure, provided the temporary use or structure is removed from the lot within 7 days of completion of the construction project or expiration of the building permit, whichever comes first.
- (3) Temporary uses and structures shall not require a regular zoning permit.
- (4) Temporary uses and structures shall meet all setback and yard requirements of Sec. 4.02(3) and 4.04 of this Ordinance.
- (5) Temporary uses and structures shall not involve the construction or alteration of any permanent structure.

**2.08 USES NOT LISTED**

- (1) **DETERMINATION OF USE CLASSIFICATION BY THE PLANNING AND ZONING COMMITTEE.** The Planning and Zoning Committee, upon referral and recommendation by the Building Inspector/Zoning Administrator, shall determine if a proposed use can be classified as one of the principal uses already listed for any of the zoning districts. If a proposed use can be so classified, then the use shall be regulated as specified by this Ordinance.
- (2) **UNCLASSIFIED USES.** A proposed use that cannot be classified as one of the principal uses shall be considered an unclassified use and shall be regulated as follows:
  - (a) The Planning and Zoning Committee, upon referral and recommendation by the Building Inspector/Zoning Administrator, shall determine if the proposed

unclassified use is similar to other uses listed for the zoning district applicable to the site of the proposed unclassified use. If so, the application for the proposed unclassified use shall be processed as specified by this Ordinance.

- (b) If the Planning and Zoning Committee determines otherwise, then the application for the proposed unclassified use shall be denied and the applicant shall be so notified in writing.
- (3) After making a determination regarding an unclassified use, the Planning and Zoning Committee shall recommend an amendment to this Ordinance adding the previously unclassified use to the table of principal uses. The recommended ordinance amendment shall be adopted prior to consideration of an application for the previously unclassified use.

## **SECTION 3 ADDITIONAL USE REQUIREMENTS**

**3.01 PURPOSE.** The purpose of these requirements is to minimize potential negative impacts from certain uses and to promote compatibility between particular uses and surrounding uses.

**3.02 APPLICABILITY.** In addition to complying with other regulations established in this Ordinance, these requirements must be met for each specific use. These requirements shall override any requirements which are described elsewhere in this Ordinance for the zoning districts, but only to the extent that they conflict with and are more restrictive than such requirements.

### **3.03 AGRICULTURAL USES**

#### **(1) AGRICULTURE**

(a) In the Residential-Large Lot (R-1), Residential-Small Lot (R-2), and Concentrated Mixed Use (CMU) Districts, the only agricultural activities that may be permitted are crop or forage production, beekeeping, floriculture, forest management and the keeping of chickens and ducks.

(b) In the Residential-Large Lot (R-1), Residential-Small Lot (R-2), and Concentrated Mixed Use (CMU) Districts, the keeping of chickens and ducks is subject to the following requirements:

- 1) Lots shall contain a minimum of 20,000 square feet.
- 2) Maximum of eight (8) total chickens and/or ducks are allowed. Male chickens (roosters) are prohibited. Hens and male ducks (drakes) are permitted.
- 3) Chickens and ducks shall be kept in an enclosure at all times. The enclosure includes the covered structure(s) and fenced area.
- 4) The enclosure shall be a minimum of 10 feet from any side or rear lot line, and completely in the rear yard of the principal structure. Setback shall be measured from fencing and structure(s).

### **3.04 RECREATIONAL USES**

#### **(1) CAMPING**

(a) Camping shall be permitted in legally established campgrounds without the issuance of a zoning permit.

(b) Camping shall be permitted on a parcel or lot, outside of a legally established campground, without the issuance of a zoning permit, subject to the following requirement(s):

1) Such camping shall not exceed 30 days in a calendar year.

(c) Camping on a lot during construction of a single family detached or two-family residence shall be allowed, subject to the following:

1) A zoning permit for a single family detached or two-family residence has been secured and a slab, crawlspace, or foundation for the single family detached or two-family residence has been installed.

2) A zoning permit which authorizes such camping has been secured.

3) An approved on-site waste disposal system, designed to accommodate the single family residence, has been installed on the property prior to the placement, erection, and/or use of the camping unit to serve as a means of sanitary waste disposal for the users of the camping unit.

4) The camping activity shall cease upon the completion of the single family detached or two-family residence on the property.

5) Renewal permits shall only be issued when substantial progress toward completion of the single family detached or two-family residence is demonstrated during the previous year.

### **3.05 RESIDENTIAL USES**

#### **(1) MULTI-FAMILY RESIDENCE**

(a) Multi-family residences shall only be allowed on parcels or lots served by public water and sewer.

#### **(2) ACCESSORY DWELLING UNIT**

(a) Not more than one (1) accessory dwelling unit shall be permitted per lot.

(b) Accessory dwelling units may be attached to or detached from the single family residence.

(c) Accessory dwelling units shall comply with the setbacks as required for principal structures.

(d) Maximum floor area for accessory dwelling units shall be provided per Sec. 4.07 of this Ordinance.



- (e) A minimum of one (1) off-street parking space shall be provided in addition to the required parking spaces for the single family residence and any other use(s) on the property requiring off-street parking per Section 5 of this Ordinance.
  - (f) Accessory dwelling units may only be permitted after the foundation for the primary residence has been completed (i.e., concrete slab and/or foundation walls).
  - (g) Occupancy of the accessory dwelling unit shall not be allowed until an occupancy certificate, pursuant to Sec. 11.02 of this Ordinance, is obtained for the primary residence.
  - (h) Accessory dwelling units are subject to the requirements for short term rentals in sub. (4).
  - (i) Accessory dwelling units shall not be conveyed or separated in ownership from the primary residence on the lot.
  - (j) Accessory dwelling units shall contain permanent provisions for living, sleeping, eating, cooking, and sanitation (i.e., living area, bedroom, kitchen, and bathroom).
- (3) MANUFACTURED HOME COMMUNITY AND MANUFACTURED/MOBILE HOME
- (a) Manufactured home communities shall only be allowed on parcels or lots served by public water and sewer.
  - (b) Manufactured/mobile homes shall only be allowed within a legally established Manufactured Home Community.
- (4) SHORT TERM RENTALS (STR)
- (a) County License. Prior to the establishment of an STR, the operator shall obtain a license from the Marathon County Health Department and maintain such license for the life of the use or until the department no longer requires such license.
  - (b) State License. Anyone who maintains, manages, or operates an STR for more than 10 nights each year is required to obtain a tourist rooming house license from the Wisconsin Department of Agriculture, Trade & Consumer Protection (DATCP).

- (c) Type of Dwelling. An STR shall only occur within a single-family detached residence or accessory dwelling unit.
- (d) Conditional Use Permit. All STR structures require a one-time Conditional Use Permit. A Conditional Use Permit shall be transferable between property owners.
- (e) Residency requirement. The operator or owner of an STR shall maintain the single family detached residence as their primary residence during the time period when rooms are offered.
- (f) Exterior character of the dwelling unit. The exterior appearance of the building shall not be altered from its single-family appearance. Signage shall conform with the standards identified in the Conditional Use Permit. However, the sign shall not exceed four (4) Square feet in size.
- (g) Food preparation. No food preparation or cooking shall be allowed in guest rooms. Food preparation or cooking shall only be allowed in kitchens.
- (h) Meals. Meals shall only be offered to overnight guests.
- (i) Maximum stay. Rentals shall not exceed 29 consecutive days. Rental activity shall be limited to 180 days within any consecutive 365-day period.
- (j) Required inspection for public safety. Before the issuance of any Conditional Use Permit, an inspection of the residential structure shall occur by the Town's Building Inspector. All STR rooms for rent shall be UDC (Uniform Dwelling Code) compliant. Inspections may be required every five years at a minimum, by discretion of the Town.
- (k) Parking. All vehicle parking (homeowners and renters) shall occur on site. No on-street parking shall be permitted.

(5) ACCESSORY RESIDENCE

- (a) Accessory residences shall be subject to the regulations herein and shall not be regulated as single-family detached residences, two-family residences, multi-family residences, or accessory dwelling units.
- (b) Accessory residences may be attached or detached dwelling units.
- (c) The setbacks shall be the required setbacks for principal structures.
- (d) One parking space shall be provided for each residential unit.

- (e) Minimum and maximum floor area for accessory residences shall be provided per Sec. 4.07 of this Ordinance.
- (f) Accessory residences shall contain permanent provisions for living, sleeping, eating, cooking, and sanitation (i.e., living area, bedroom, kitchen, and bathroom).

### **3.06 COMMERCIAL USES**

#### **(1) HOME OCCUPATIONS**

- (a) HOME OCCUPATION-MINOR. A home occupation-minor use shall comply with the following performance standards:
  - 1) The use of the dwelling unit, its attached garage, and/or an accessory building on the same parcel as the dwelling unit for the home occupation-minor shall be clearly incidental and subordinate to its use for residential purposes by its occupants, and shall under no circumstances change the residential character thereof.
  - 2) The home occupation-minor shall be conducted by the resident(s) of the dwelling unit on the property. Other persons may be employed by the home occupation, but no more than one non-resident shall work on the premises.
  - 3) A home occupation-minor may be conducted in a dwelling unit, its attached garage, and/or an accessory building on the same parcel as the dwelling unit. The total floor area dedicated to the home occupation-minor shall be no more than 25% of the floor area of the dwelling unit.
  - 4) Such use shall not involve any outdoor storage or display of any products, materials, equipment, dumpsters, or machinery used in conjunction with the home occupation-minor.
  - 5) A maximum of one on-site vehicle and one trailer bearing business insignia or used in conjunction with the home occupation-minor may be stored outdoors, and visible from rights-of-way and neighboring properties. Any additional on-site vehicle(s) or trailer(s) bearing business insignia or used in conjunction with the home occupation-minor shall be stored indoors or shall not be visible from the rights-of-way and neighboring properties.
  - 6) The home occupation-minor shall not include the conduct of retail, wholesale, or personal/professional service business on the premises, except for the sale of products or services produced by the home occupation-minor.

- 7) No equipment or process shall be used in such home occupation-minor which creates a nuisance due to noise, dust, vibration, glare, fumes, odors, or electrical interference detectable to the normal senses off the lot. In the case of electrical interference, no equipment or process shall be used which creates audible or visual interference in any radio or television receivers off the premises.
- 8) Deliveries to or shipments from the property of products, materials, equipment, or machinery used in conjunction with a home occupation minor shall not exceed five (5) per week.

(b) HOME OCCUPATION-MAJOR. A home occupation-major use shall comply with the following performance standards:

- 1) The home occupation-major shall be conducted by the resident(s) of the dwelling unit on the property. Other persons may be employed by the home occupation, working on or off-site.
- 2) If located in a dwelling unit, the home occupation-major shall occupy no more than 50 percent of the floor area of the dwelling unit. If located in accessory buildings, the home occupation-major shall occupy no more than 100 percent of the floor area of the dwelling unit. If located in both the dwelling unit and accessory buildings, the total floor area dedicated to the home occupation-major shall not exceed 100 percent of the floor area of the dwelling unit.
- 3) Such use shall not involve any outdoor display of any products offered for sale or produced on the premises in conjunction with the home occupation-major. Outdoor storage of products, materials, equipment, dumpsters, or machinery used in conjunction with the home occupation shall be permitted if the outdoor storage areas are provided with fencing or vegetative screening so that such storage is not visible from public rights-of-way nor neighboring properties. The total area of outdoor storage of products, materials, equipment, dumpsters, or machinery used in conjunction with the home occupation shall not exceed 100 percent of the floor area of the dwelling unit.
- 4) A maximum of one on-site vehicle and one trailer bearing business insignia or used in conjunction with the home occupation-major may be stored outdoors, and visible from rights-of-way and neighboring properties. Any additional on-site vehicle(s) or trailer(s) bearing business insignia or used in conjunction with the home occupation-major shall be stored indoors or shall not be visible from the rights-of-way and neighboring properties.

- 5) The home occupation-major shall not include the conduct of retail, wholesale, or personal/professional service business on the premises, except for the sale of products or services produced by the home occupation-major.

(2) SPECIAL EVENT VENUE

- (a) The number of special events shall not exceed six (6) per calendar year. Any single event shall not exceed three (3) consecutive days.
- (b) The parcel of land containing the special event venue shall directly abut a public road.
- (c) Access to such facility shall only be taken from a public road.
- (d) Off-street parking shall be established in compliance with Section 5 of this Ordinance, except the parking area is not required to be paved with concrete, asphalt, or gravel. There shall be no on-street parking associated with the special event venue.
- (e) Buildings and structures associated with special event venues shall be located a minimum of 200 feet from any off-premise residential structures existing at the time of establishment of the special event venue.
- (f) Special event venues shall be located on a parcel of at least 10 acres.

(3) ADULT ENTERTAINMENT/ADULT ORIENTED ESTABLISHMENT

- (a) Separation Requirements. No adult entertainment/adult oriented establishment use shall be permitted:
  - 1) Within 500 feet of any other existing adult entertainment/adult oriented establishment use, and/or
  - 2) Within 1,000 feet of any residentially zoned district (including Residential-Large Lot/R-1, Residential-Small Lot/R-2, and Concentrated Mixed Use/CMU districts), or any of the following residentially related uses:
    - a) Churches, monasteries, chapels, synagogues, convents, rectories, religious article, or religious apparel stores;
    - b) Schools up to and including the 12th grade, including their adjunct play areas; and

c) Public playgrounds, public swimming pools, public parks, and public libraries.

(b) Measurement of Distances. For the purposes of this section spacing distances shall be measured as follows:

- 1) From all property lines of any adult entertainment/adult oriented establishment use;
- 2) From the outward line of the boundary of all residential zoning districts;
- 3) From all property lines of any residential-related use as enumerated in subsection (a)2)a through c) above.

**3.07 INSTITUTIONAL USES (NONE)**

**3.08 INDUSTRIAL USES**

(1) NONMETALLIC MINING

(a) General Requirements. Mining of nonmetallic minerals and the processing for manufacture of materials incidental to such extraction and the erection of buildings and the installation of equipment and machinery are subject to the following requirements:

- 1) Aerial Photograph and Map.
  - a) The boundary of the affected parcel and any adjacent parcel, pipelines, railroads, streams, utilities, and wetlands on the proposed extraction site and any adjacent parcel.
  - b) The name of the owner of each adjacent parcel and the location of all structures within 300 feet of the proposed mine site.
  - c) The proposed location, extent, and depth of the intended sand, gravel, and rock excavation, showing the setback distances.
  - d) The proposed location of any ponds, sediment basins, and stockpiles showing the setback distances.
  - e) The surface drainage and estimated depth to groundwater.
- 2) Operational Information.
  - a) The duration of any applicable lease.

- b) The estimated date that operations will commence and terminate.
- c) Anticipated hours of operation.
- d) The proposed primary travel routes to transport material to and from the site.
- e) A description of the excavation and processing equipment to be used.
- f) A description of measures to be taken to screen or buffer the operation from view from any adjacent residential parcel.
- g) A description of measures to be taken to control dust, noise, and vibrations from the operation.

3) Operation.

- a) All blasting must be done by a state licensed and certified blaster, who must have a certificate of liability or proof of liability insurance.
- b) All excavation equipment must be constructed, maintained, and operated in such a manner as to eliminate, as practicable, dust, noise, or vibration that might adversely affect or injure any person living in the vicinity of the operation.
- c) Any excavation access road must have and be maintained with a dustless surface.
- d) Operations must be conducted in such a manner that any water runoff from the operation does not adversely affect any adjacent parcel.
- e) All equipment and temporary structures, such as stone crusher, conveyor, or screener, must be removed from the site within 90 days of the termination of extraction operations.

4) Setback Requirements.

- a) The excavation must be setback at least 100 feet from any existing occupied structure other than the owner's.
- b) All operations shall be at least 50 feet from the centerline of any right-of-way and 10 feet from any property line unless there is a written agreement between adjoining owners both of whom hold valid nonmetallic mining permits under which they both agree to mine up to their common property line. Mining up to or into the right-of-way may

be authorized where it is determined by the unit of government having jurisdiction over the road that such mining would be beneficial.

- c) All accessory uses such as offices and parking areas shall be at least 75 feet from any right-of-way or property line.
- 5) Nonmetallic mining shall comply with the terms of Marathon County Nonmetallic Mining Reclamation Code, Chapter 21, General Code of Ordinances.
- 6) All nonmetallic mining shall be required to provide for the proper closure and reclamation of the extraction site to an agricultural use.
- 7) Nonmetallic mining activity and operation shall be consistent with Wisconsin Statute, Chapter 91, Farmland Preservation, 91.46(6)

**3.09 MISCELLANEOUS USES (NONE)**



## SECTION 4 GENERAL REQUIREMENTS

**4.01 COMPLIANCE.** All development shall comply fully with the requirements of this Section.

### 4.02 DISTRICT REQUIREMENTS.

- (1) Developments shall meet the minimum requirements for the applicable district shown in the tables in sub. (3).
- (2) HOW TO USE TABLE OF DISTRICT REQUIREMENTS.

**Figure 4-1: How to Use Table of District Requirements**

Zoning Districts	Individual Lot Requirements			Setbacks (ft.)				
	Min. Lot Area	Min. Lot Width (ft.)	Max. Impervious Surface Ratio (% lot coverage)	Front	Side (Principal)	Side (Accessory)	Rear (Principal)	Rear (Accessory)
AG/F Agricultural/Forestry District	1 acre	150	25	25	20	20	50	20
REC Recreational District	1 acre	150	25	25	20	20	50	20
R-1 Residential-Large Lot District	40,000 sq. ft.	150	30	25	10	10	50	10
R-2 Residential-Small Lot District	20,000 sq. ft.	100	30	25	10	5	25	5
CMU Concentrated Mixed Use District	6,000 sq. ft.	60	75	10	5	3	5	3
GC General Commercial District	1 acre	150	45	25	10	10	20	20
IC/LI Intensive Commercial/Light Industrial District	1 acre	150	60	25	10	10	20	20

Refers to the minimum size for an individual lot shown in acres or square feet.

Refers to the minimum width of a lot (see "Lot Width" definition).

Refers to the minimum allowable distance between a front lot line and a structure. Also see s. 4.04, Setbacks from Roads.

Refers to the minimum allowable distance between a rear lot line and a principal or accessory structure.

Refers to the maximum percentage of a lot that may be covered with impervious surfaces (e.g., buildings, decks, pavements, gravel, etc.)

Refers to the minimum allowable distance between a side lot line and a principal or accessory structure.

(3) TABLE OF DISTRICT REQUIREMENTS

Zoning Districts	Individual Lot Requirements			Setbacks (ft.)					
	Min. Lot Area	Min. Lot Width (ft.)	Max. Impervious Surface Ratio (% lot coverage)	Front	Side (Principal)	Side (Accessory)	Rear (Principal)	Rear (Accessory)	
AG/F Agricultural/Forestry District	1 acre	150	25	25	20	20	50	20	
REC Recreational District	1 acre	150	25	25	20	20	50	20	
R-1 Residential-Large Lot District	40,000 sq. ft.	150	30	25	10	10	50	10	
R-2 Residential-Small Lot District	20,000 sq. ft.	100	30	25	10	5	25	5	
CMU Concentrated Mixed Use District	6,000 sq. ft.	60	75	10	5	3	5	3	
GC General Commercial District	1 acre	150	45	25	10	10	20	20	
IC/LI Intensive Commercial/Light Industrial District	1 acre	150	60	25	10	10	20	20	

NOTE: Unless specifically exempted by this Ordinance, all structures shall also comply with the requirements of Sec. 4.04, setbacks from roads.

#### 4.03 LOT REQUIREMENTS.

- (1) No lot shall hereafter be created which does not meet the minimum width and area requirements of this Ordinance. No lot shall be so reduced that it fails to meet any density, dimensional, or other requirement of this Ordinance.
- (2) LOT OF RECORD REQUIRED. Every building hereafter erected, structurally altered, or relocated shall be placed on a lot of record.
- (3) ACCESS TO ROAD.
  - (a) Except as provided in sub. (c), no lot shall hereafter be created which does not have direct access to and abut a public road.
  - (b) For lots created prior to the effective date of this ordinance, as described and recorded in the Marathon County Register of Deeds, no building shall hereafter be placed or constructed on said lot if the lot does not have direct access to and abut a public or private road.
    - 1) The property owner shall be responsible for securing such access.
    - 2) In the event any lot which was created prior to the effective date of this Ordinance does not have direct access to a public road or a private road, the owner or their authorized representative shall, at their sole expense, construct and dedicate to the Town a road meeting the geometric design standards set forth in §82.50, Wis. Stats., and Chapter Trans 204, Wis. Admin. Code. The road shall also meet the requirements set forth in Sec. 6.01, town roads, of this Ordinance.
  - (c) Exception to Road Access Requirements.
    - 1) Lots not intended for building or construction purposes may be created without direct access to and abutting a public road, provided the lot is created via certified survey map (CSM) or subdivision plat and a non-buildability statement is included on the face of the CSM or plat and access to the lot is provided by an ingress/egress easement to a dedicated public road.
      - a) The ingress/egress easement shall be a minimum of 33 feet wide. A 66 foot wide ingress/egress easement may be required by Marathon County in accordance with the Marathon County General Code of Ordinances.

- (4) In any district, more than one (1) building housing a principal use may be erected on a single lot, except as follows:
- (a) Only one (1) single family residence and one (1) accessory dwelling unit shall be permitted on a single lot.
  - (b) Only one (1) duplex shall be permitted on a lot.
  - (c) Only one (1) manufactured home shall be permitted on a lot, unless the lot is authorized as a manufactured home community.
- (5) LOTS CREATED PRIOR TO THE EFFECTIVE DATE OF THIS ORDINANCE. Lots which were created before the effective date of this Ordinance shall be considered building sites provided they meet the criteria established in Sec. 4.03(3)(b) and both subs.(a) and (b) below:
- (a) They are of record in at least one of the following forms to establish the lot's date of creation:
    - 1) A recorded land subdivision or certified survey map on file in the Marathon County Register of Deeds Office showing the lot in its present form.
    - 2) A lot of record by means of a deed or land contract on file in the Marathon County Register of Deeds Office and which predates the effective date of this Ordinance.
    - 3) A recorded condominium plat.
  - (b) Minimum lot requirements for lots created prior to the effective date of this Ordinance. A legally-created lot or parcel that met minimum area and width requirements when created but does not meet current lot size requirements may be used as a building site if the following apply:
    - 1) The substandard lot or parcel was never reconfigured or combined with another lot or parcel by plat, survey, or deed; and
    - 2) The substandard lot or parcel is developed to comply with all other ordinance requirements.
- (6) Lots which qualify as building sites as provided in sub. (5) above may be enlarged through acquisition of adjacent property, but need not comply with the provisions of Sec. 4.02(3), table of district requirements. Any such lots which have been enlarged through land acquisition or combining of separate parcels into a single legal description shall not be thereafter reduced or rearranged except in compliance with Sec. 4.02, district requirements.

#### **4.04 SETBACKS FROM ROADS.**

Setbacks from public roads and railroad right-of-ways shall be measured from the road or railroad right-of-way. Setbacks from private easement roads shall be measured from the described easement as recorded in the Marathon County Register of Deeds or, in the case of an easement that does not have a legal description, setbacks shall be measured from the nearest point on the edge of the traveled way.

##### **(1) ROAD CLASSIFICATIONS:**

- (a) Class A: All State and federal highways are hereby designated as Class A highways.
- (b) Class B: All County trunk highways are hereby designated as Class B highways. For the purpose of this Ordinance any road will be considered as a County trunk after it has been placed on the County trunk system by the County Board and approved by the State Department of Transportation.
- (c) Class C: All town roads, public streets and highways not otherwise classified are hereby designated Class C highways.

##### **(2) SETBACKS:**

- (a) Class A Highways. Except as provided in subs. (e), (f), (g), and (i), the minimum setback for all structures fronting Class A highways shall be 110 ft. from the centerline of the right-of-way and 50 feet from the edge of the right-of-way, whichever distance is greater, except that for any freeway or divided Class A highway the setback distance shall be 100 feet from the right-of-way line.
- (b) Class B Highways. Except as provided in subs. (e), (f), (g), and (i), the minimum setback for all structures fronting Class B highways shall be 75 feet from the centerline of the right-of-way and 42 feet from the edge of the right-of-way, whichever distance is greater.
- (c) Class C Highways. Except as provided in subs. (e), (f), (g), and (i), the minimum setback for all structures fronting Class C highways shall be 63 feet from the centerline of the right-of-way and 30 feet from the edge of the right-of-way, whichever distance is greater.
- (d) Private Easement Roads and Railroad Right-of-Ways. Except as provided in subs. (e), (f), (g), and (i), the minimum setback for all structures fronting private easement roads or railroad right-of-ways, except private easement roads serving only one (1) lot, shall be 30 feet from the described easement or right-of-way. No setback shall be required from private easement roads which serve only one (1) lot. If the width of the private easement road is described

by plat, survey, deed or similar document recorded in the Marathon County Register of Deeds, the setback shall be measured from the edge of the described easement as recorded in the Marathon County Register of Deeds. If the width of the private easement road or access easement is not so described, then the setback shall be measured from the nearest point on the edge of the traveled way.

(e) Concentrated Mixed Use District. Except as provided in subs. (f), (g), and (i), the minimum setback from roads for all structures in the Concentrated Mixed Use District shall be 25 feet from the right-of-way line.

(f) Commercial Structures. All commercial structures greater than 35 feet in height shall be 1.1 times the height of the structure from the right-of-way line.

(g) Setback Reduction.

1) Where each side of the proposed building location is occupied by an adjacent principal building located closer to the road than the required setback and located within 200 feet of the proposed building footprint, the required setback for the proposed building shall be the average of the setbacks of the adjacent principal buildings, except in no case shall the required road setback be less than 10 feet from the right-of-way.

2) Where one side of the proposed building location is occupied by an adjacent principal building located closer to the road than the required setback and located within 200 feet of the proposed building footprint, the required setback for the proposed building shall be the average of the setback of the adjacent principal building and the setback required for that particular road.

3) Setback reduction does not apply to commercial structures greater than 35 feet in height.

(h) Vision Clearance Triangle

1) In each quadrant of every public street intersection or street railroad intersection, there shall be a vision clearance triangle bounded by the street centerlines and a line connecting points on them, as follows:

a) Class A Highways: 300 feet

b) Class B Highways: 200 feet

c) Class C Highways: 150 feet

**Figure 4-2: Vision Clearance Triangle**

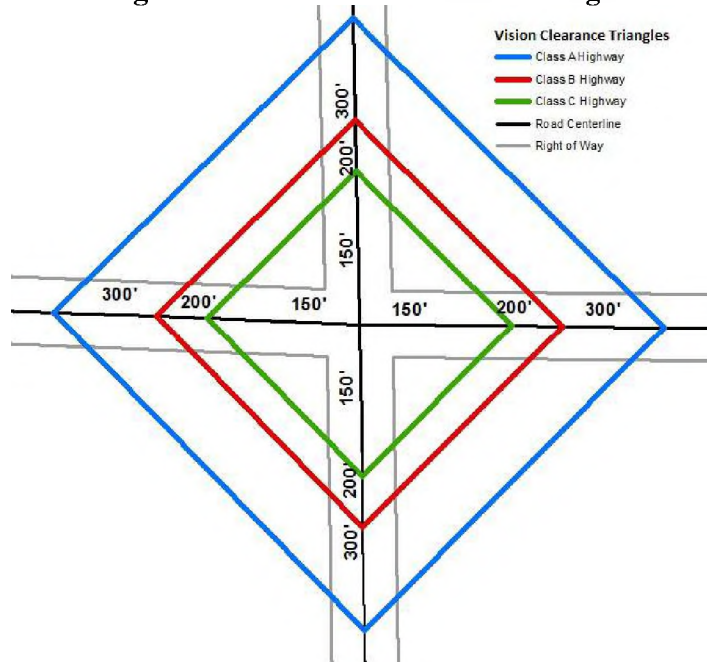

- 2) Within a vision clearance triangle, no structure or object of natural growth shall be constructed, maintained, or permitted between a height of 30 inches and eight (8) feet above the elevation of the street or highway grade at the centerline, except as exempted in sub. (i).

**Figure 4-3: Clear Vision Area**

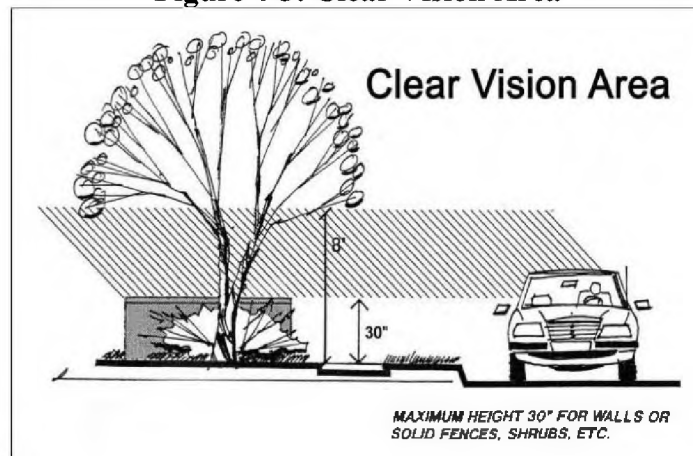

- (i) Exemptions. The following structures shall be permitted within the required setbacks from roads and vision clearance triangles, provided they do not violate any other provisions of this Ordinance:
  - 1) Open Fences, provided they are not located within a public right-of-way.

- 2) Petroleum and gas transmission lines, telephone, telegraph, cable television, and power transmission poles and lines and portable equipment both above and below ground that is readily removable in its entirety. Additions to and replacement of all such structures may be made, provided the owner will file with the Town Board an agreement in writing that the owner will move or remove all new construction, additions, and replacements erected after the adoption of this chapter at their expense, when necessary to the public interest (i.e., highway construction, airport, sewer and water lines, etc.)
- 3) Underground structures not capable of being used as foundations for future prohibited over-ground structures.
- 4) Signs placed by the public authorities for the guidance or warning of traffic.
- 5) Structures which are not buildings and which are less than 6 inches above preconstruction grade, including but not limited to sidewalks, driveways, patios, and at-grade decks.
- 6) Outdoor lighting installations, provided these items are not located within a public right-of-way.
- 7) Structures such as ramps and landings, lifts, or elevator housing, which are designed and intended to comply with the requirements of the Americans with Disabilities Act or fair housing laws to make existing buildings accessible to disabled people, and where no feasible alternative locations exist.
- 8) Overhanging eaves and gutters, provided they extend not more than 2 feet into the required setback and are not located within a public right-of-way.

**4.05 HEIGHT REQUIREMENTS.**

- (1) HEIGHT LIMITATION. Except as provided below and in subs. (2) and (3), no building or structure shall exceed 35 feet in height above the finished grade elevation.
- (2) EXEMPTIONS. The following shall be exempted from the height requirements of this Section:
  - (a) Architectural projections such as: spires; belfries; parapet walls; domes; chimneys; and cupolas.
  - (b) Agricultural structures such as: barns; silos; and grain storage structures.



- (c) Special structures such as: mechanical/elevator penthouses; grain elevators; observation/lookout towers on public property; utility and telecommunication poles, towers, masts, and associated appurtenances; windmills; cooling towers; and stacks.
- (3) Public or quasi-public facilities such as churches, schools, hospitals, sanitoriums, monuments, libraries, and government offices and stations may be erected to a height of 60 feet, provided that all required setbacks and yards are increased by not less than one foot for each foot the structure exceeds 35 feet in height.

**4.06 FRONT, REAR, AND SIDE YARDS.** Except as dictated by Sec. 4.04, setbacks from roads, the following shall apply to front, rear, and side yards:

- (1) **HOW MEASURED.** The yard distances shall be measured from the nearest portion of the structure, except that the first 2 feet of overhanging eaves and gutters of buildings shall not be included where the yard requirement exceeds 5 feet.
- (2) **COMMERCIAL STRUCTURES.** All commercial structures greater than 35 feet in height shall be 1.1 times the height of the structure from the front, rear, and side lot lines.
- (3) **EXEMPTIONS.** The following structures are permitted in front, rear, and side yards provided they do not violate any other provision of this Ordinance:
  - (a) Structures which are not buildings and which are less than 6 inches above preconstruction grade, including but not limited to driveways, patios, and at-grade decks.
  - (b) Fences, provided they are not located within a public right-of-way or vision clearance triangle. Open fences are permitted in the vision clearance triangle, provided they are not located within a public right-of-way.
  - (c) Public utility poles, lines, and related equipment without permanent foundations.
  - (d) Signs, as provided by Section 7 of this Ordinance.
  - (e) Outdoor lighting installations, provided these items are not located within a public right-of-way.
  - (f) Structures such as ramps and landings, lifts, or elevator housing, which are designed and intended to comply with the requirements of the Americans with Disabilities Act or fair housing laws to make existing buildings accessible to disabled people, and where no feasible alternative locations exist.

- (4) **APPLICABILITY TO FUNCTIONAL APPURTENANCES.** Any functional appurtenances to a principal building, such as decks, stairways, and balconies, which are attached to the principal building shall comply with the yard requirements for principal structures.

**4.07 FLOOR AREA REQUIREMENTS.**

- (1) Except as specified in subs.(2) through (5), the minimum floor area for one-story dwelling units in all districts shall be 1,000 square feet, and the minimum floor area for split-level, two-story and bi-level dwelling units shall be 1,500 square feet.
- (2) For multi-family residences, the minimum floor area for each dwelling unit shall be 600 square feet.
- (3) For accessory dwelling units, the maximum floor area shall be less than 1,000 square feet.
- (4) For manufactured/mobile homes, the minimum floor area shall be 500 square feet.
- (5) For accessory residences, the minimum floor area shall be 600 square feet. The maximum floor area shall be 100% of the floor area of the nonresidential use in which the accessory residence serves or 3,000 square feet, whichever is less.

**4.08 ACCESSORY STRUCTURES.** Accessory structures are permitted subject to the following:

- (1) **PERMIT REQUIRED.** Accessory structures, including shipping containers used for accessory storage, shall require a regular zoning permit except:
  - (a) Minor structures such as:
    - 1) Birdhouses
    - 2) Yard light poles
    - 3) Birdbaths
    - 4) Doghouses (housing dogs which are licensed as the personal pets of the residents of the property)
    - 5) Playhouses/treehouses
    - 6) Noncommercial fuel storage tanks and pumps
    - 7) Clothes line poles
    - 8) Lawn ornaments
    - 9) Flag poles
    - 10) Mailboxes
    - 11) Garbage containers
    - 12) Ice fishing shanties and hunting stands/blinds
    - 13) School bus waiting shelters

- 14) Farm livestock hutches
- 15) Firewood storage structures with no more than three sides and which are less than or equal to 48 square feet and six feet in height.

(b) Fences.

(2) Accessory structures shall be located on the same lot as the principal use to which it is accessory.

(3) Accessory structures shall not be permitted until its associated principal structure is present or under construction.

(4) SHIPPING CONTAINER REQUIREMENTS

(a) A zoning permit is required for the placement of a shipping container on a property for accessory storage use.

(b) Shipping containers used for accessory storage shall only be permitted in the Agricultural/Forestry (AG/F), Recreational (REC), General Commercial (GC), and Intensive Commercial/Light Industrial (IC/LI) Districts.

(c) Shipping containers used for accessory storage shall be prohibited in the Residential-Large Lot (R-1), Residential-Small Lot (R-2), and Concentrated Mixed Use (CMU) Districts.

(d) Shipping containers shall be solid color, and shall be earth-tone color or the same or similar color as the principal building on the lot.

(e) Lettering, wording and advertising on shipping containers shall be prohibited.

(f) There shall be no more than two (2) shipping containers permitted on a lot or parcel unless a conditional use permit is issued by the Town Board for additional shipping containers.

(g) The use of shipping containers as a principal structure or dwelling shall be prohibited.

(5) ITEMS PROHIBITED AS ACCESSORY STRUCTURES. Such items as, but not limited to:

- (a) Boats
- (b) Truck bodies
- (c) Manufactured homes
- (d) Buses
- (e) Railroad cars
- (f) Trailers
- (g) Campers

## **SECTION 5 PARKING, LOADING, AND ACCESS/DRIVEWAY REQUIREMENTS**

### **5.01 PURPOSE AND APPLICABILITY**

- (1) **PURPOSE.** The intent of this Section is to prevent or alleviate the congestion of the public streets and promote the safety and welfare of the public by establishing minimum requirements for off-street parking and loading according to the use of the property, and to promote safety and convenience for people by requiring that parking areas and driveways be located and constructed according to good standards for visibility, accessibility and safety. It is the responsibility of property owners to provide adequate parking to meet their specific needs.
- (2) **APPLICABILITY.**
  - (a) The requirements of this Section shall apply to all uses other than agricultural uses.
  - (b) Except for agricultural uses, all uses hereafter established, expanded, changed in use to create a need for ten percent (10%) greater parking capacity, reduced in size, or alteration to existing surfaces shall provide off-street parking and loading space in accordance with the standards set forth in this Section. Alteration means adding asphalt or concrete to a gravel parking lot or parking space or removing asphalt or concrete from a parking lot or parking space and exposing the gravel base course and repaving of such area, but does not include seal coating or lining/stripping.

### **5.02 OFF-STREET PARKING REQUIREMENTS**

- (1) **ACCESS.** Adequate access to a public street shall be provided for each parking space, and driveways shall be at least 10 feet wide.
- (2) **DIMENSIONS.** The Minimum Dimensions of each parking space shall be 9 feet by 18 feet, except for properly signed spaces provided for use by handicapped persons.
- (3) **PARKING SPACES FOR HANDICAPPED PERSONS**
  - (a) Any parking area to be used by the general public shall provide parking spaces designated and located to adequately accommodate handicapped persons, and these shall be clearly marked as such.
  - (b) Handicapped stalls shall be located in close proximity to the principal entrance(s).
  - (c) Parking spaces shall be designed in accordance with the state and federal building code and, as a minimum, shall meet the Federal ADA standards.

(d) Handicap ramps shall meet the Federal ADA standards.

(4) LOCATION.

(a) Parking Spaces shall be on the same lot as the Principal Use or on an adjoining lot under the same ownership as the lot containing the use it serves.

(b) Adjoining lots used to provide required off-street parking shall be located in a Concentrated Mixed Use (CMU), General Commercial (GC), or Intensive Commercial/Light Industrial (IC/LI) district.

(c) Except as provided in (d), no parking space shall be located closer than 5 feet from a property line or public right-of-way.

(d) No parking stall, except in residential districts, shall be closer than 25 feet to a Residential District lot line or a street right-of-way opposite a Residential District.

(5) DESIGN STANDARDS

(a) All parking lot development or expansion of existing parking lots that need to accommodate more than ten (10) parking stalls shall be subject to development plan design standards as identified below:

- 1) Drainage. All parking areas shall provide for proper drainage of surface water to prevent the drainage of such water onto adjacent properties. On-site storm drainage shall be provided in accordance with the State Plumbing Code.
- 2) Protection Devices Barriers, curbing, or wheel stops shall be installed and so located as to prevent any portion of a vehicle from projecting beyond property lines, into any landscaping and screening, or into a pedestrian space. Such barriers, curbs or wheel stops shall be constructed and anchored to prevent their dislocation.
- 3) Surfacing. Parking areas, including stalls and access ways, shall be either concrete or asphalt. Parking areas designed solely for heavy duty vehicle (e.g., semi-truck, garbage truck, dump truck, passenger bus, etc.) traffic and parking may provide a gravel surface under the following conditions:
  - a) The entrance must be asphalt or concrete for at least the first twenty-five (25) feet from the right-of-way, except only asphalt shall be allowed within the road right-of-way.

b) The gravel must be periodically graded and maintained in a dust free manner, free of debris, weeds and other plant materials.

c) The street adjoining the driveway must be free of gravel from the parking lot.

4) Landscaping.

a) Parking areas containing 10 or more spaces which adjoin residential lots shall be visually screened from the residential lots with a solid wall, fence, or evergreen planting of equivalent visual density, or other effective means, built and maintained to a minimum height of 4 feet in height.

(6) MAINTENANCE

(a) Parking Lot Conditions. The owner of property used for off-street parking shall maintain such area in good condition without holes and free of all weeds, standing water, trash, abandoned or junk vehicles and other debris.

(b) Lighting. Parking lot and loading space lighting fixtures shall be of a full cut-off type to avoid light spilling over onto adjacent properties and public rights-of-way. Compliance with this requirements shall be supported by a photometric lighting study completed by a qualified individual or firm.

(c) Striping. All parking areas shall be striped to delineate parking stall locations.

(d) Maneuvering. All parking and loading spaces shall be designed to provide safe maneuvering to occur within the property line.

(e) Snow storage. Snow storage must be provided on-site or shall be removed from the site and properly disposed of in a timely fashion. Snow storage shall be prohibited in a public road or railroad right-of-way.

(7) NUMBER OF PARKING SPACES REQUIRED.

(a) Except as provided in sub. (b), the minimum number of off-street parking spaces to be provided shall be in accordance with Table 5-1.

(b) Exceptions.

1) Multiple Uses on a Lot. In developments involving the establishment or addition of two or more uses on one lot or parcel, shared parking arrangements shall be encouraged, provided it can be shown that the number of spaces can meet the parking needs of the multiple establishments. Shared parking agreements and cross-access easements

may be required as part of approval. The Planning & Zoning Committee may allow a reduction of required parking spaces below the requirements described in Table 5-1, without a variance, if the applicant or property owner can prove:

- a) Peak demands for individual uses on the lot or parcel do not coincide,  
or
  - b) The same parking space can simultaneously serve both uses.
- 2) The Planning & Zoning Committee may allow a reduction of required parking spaces below the requirements described in Table 5-1, without a variance, if the applicant or property can prove, through submittal of a detailed parking analysis/study completed by a qualified individual/firm, that the subject use will not warrant the minimum number of parking spaces described in Table 5-1.
- (c) Uses not enumerated. In the case of uses specifically not listed in Table 5-1, the minimum number of parking spaces shall be determined by the Planning & Zoning Committee based upon requirements for similar uses.

(TABLE 5-1, MINIMUM OFF-STREET PARKING SPACE REQUIREMENTS,  
BEGINS ON NEXT PAGE)

**Table 5-1: Minimum Off-Street Parking Space Requirements**

Type of Use	Minimum Required Off-Street Parking Spaces
<b>RECREATIONAL USES</b>	
Indoor Recreation	1 space per 200 sq. ft. of useable floor area
Indoor Shooting Range	
<b>RESIDENTIAL USES</b>	
Single Family Detached Residence	2 spaces per dwelling unit
Two-Family Residence (Duplex)	
Multi-Family Residence (3+ Units)	
Mobile/Manufactured Home	
Short Term Rental	2 spaces plus 1 space per rental room
Boardinghouse	1 space per bedroom or sleeping room
<b>COMMERCIAL USES</b>	
Hotel/Motel	1 space per rental room plus 1 space per 3 employees during peak shifts
Artisan Gallery/Studio	1 space per 200 sq. ft. of useable floor area
Retail	
Personal Service Establishment	
Professional Office/Service Establishment	
Financial Institution (e.g., bank, credit union)	
Medical/Dental Facility/Clinic	
Veterinary Clinic	
Restaurant/Tavern	
Winery/Brewery	
Bakery	
Group Day Care Center	
Automobile Sales/Service	
Recreational Vehicle Sales/Service	
Gas Station/Carwash	
Farm Implement Sales/Service	
Indoor Commercial Entertainment Facility (e.g., concert venue, bowling alley, etc.)	
Special Event Venue (e.g., wedding barn, concert venue, etc.)	
Indoor Theater	
Contractor Storage Yard	
Kennel	
Commercial Radio/TV Broadcast Studio	1 space per employee during peak shifts
Adult Entertainment/Adult-Oriented Establishment	1 space per 200 sq. ft. of useable floor area
Commercial Trucking Establishment	1 space per employee during peak shifts
Lumber/Building Supply Yard	
Home Occupation-Major	1 space per 200 sq. ft. of useable floor area
Home Occupation-Minor	



**Table 5-1: Minimum Off-Street Parking Space Requirements (Continued)**

Type of Use	Minimum Required Off-Street Parking Spaces
<b>INSTITUTIONAL USES</b>	
Places of Worship	1 space per 3 persons permitted at maximum capacity
School/College/University	1 space per 200 sq. ft. of useable floor area
Municipal Building	
Social Clubs/Lodges	1 space per 3 persons permitted at maximum capacity
Funeral Home	
Institutional Residential	0.5 spaces per bed
Community Living Arrangement	
Library/Museum	1 space per 200 sq. ft. of useable floor area
Post Office	
<b>INDUSTRIAL USES</b>	
Sawmill/Planing Mill	
Asphalt/Concrete Plant	
Solid Waste Facility (e.g., Landfill)	
Bulk Storage of Fuel Products	
Manufacturing, Assembly, Processing	1 space per employee during peak shifts
Salvage Yard	
Wastewater Treatment Plant	
Slaughterhouse	
Warehouse	
<b>MISCELLANEOUS USES</b>	
Animal Shelters/Pounds	1 space per employee during peak shifts

**NOTE:** Useable floor area excludes hallways, bathrooms, utility or storage areas, and any areas not accessible to the general public.

**5.03 LOADING REQUIREMENTS**

- (1) Any use which requires deliveries or shipments shall provide sufficient off-street loading and unloading space so that no public street, alley, or access to any parking area is blocked by such activities.
- (2) The loading and unloading space shall be separate from any parking aisle or parking spaces unless delivery or pickup activities are scheduled for hours when the parking area is not in use.

**5.04 ACCESS/DRIVEWAY REQUIREMENTS**

- (1) Every use shall have access to a public or private road. However, property owners have the responsibility of securing the access.
- (2) No direct access shall be permitted to an existing or proposed public right-of-way without the permission of the entity maintaining access control over that public right-of-way.

- (3) For all uses, except Agricultural Uses, no more than 2 driveways per lot shall be permitted.
- (4) DRIVEWAY WIDTH.
  - (a) For all Residential Uses, access driveways shall be at least 15 feet wide and not more than 24 feet wide.
  - (b) Access driveways for all other uses, except Agricultural Uses, shall be at least 20 feet wide and not more than 35 feet wide. Such drives may be reduced to 10 feet wide if they are enter-only or exit-only drives.
- (5) SETBACK.
  - (a) Except as provided in (b) below, all access driveways shall be placed such that the driveway edge nearest to a neighbor's lot line is at least 5 feet from the neighbor's lot line, unless driveways are shared by adjoining property owners.
  - (b) No access driveway, except in residential districts, shall be closer than 25 feet to a residential district lot line or a street right-of-way opposite a residential district.
- (6) All primary access driveways serving R-1, R-2, CMU, GC, & IC/LI lots shall be either concrete or asphalt, except only asphalt shall be allowed within the road right-of-way.
- (7) LOCATION.
  - (a) Access drives shall be located opposite median crossovers, where present.
  - (b) At road intersections, the midpoint of access driveways shall be located at least 100 feet from the point of intersection of the road edges. For lots existing prior to the effective date of this Ordinance which cannot meet this provision, one access driveway shall be permitted.

## SECTION 6 SUPPLEMENTAL REQUIREMENTS

### 6.01 TOWN ROADS

- (1) **PURPOSE.** The purpose of these regulations is to establish minimum standards for town roads in the Town of Ringle, and to establish procedures for the acceptance of town roads in the Town of Ringle.
- (2) **APPLICABILITY.** These regulations shall apply to all town roads and streets in the Town of Ringle.
- (3) **PUBLIC ROAD ACCEPTANCE AND CONSTRUCTION STANDARDS**
  - (a) **Petition/Submittal.**
    - 1) The property owner must present a state plat or certified survey map, as may apply, with the appropriate language for acceptance of the road by the town and in conformity with the relevant requirements of Wisconsin State Statute Chapter 236.
    - 2) The property owner must also present a plan for the proposed road. This plan may be a map or sketch of the proposed road, but must be prepared by a professional engineer registered in the State of Wisconsin and must be prepared in conformity with the relevant requirements of Wisconsin State Statutes Chapters 82 through 86.
    - 3) The state plat or certified survey map, as well as the plan for the road, must be reviewed and approved by an engineer who has been selected by the Town Board.
  - (b) **Design Standards.**
    - 1) **Right-of-Way Width.** The right of way shall be four rods (66 feet) wide.
    - 2) **Circulation.** All necessary turn-arounds and cul-de-sacs shall be determined by an engineer who has been selected and approved by the Town Board.
    - 3) **Road Bed and Base.** The road bed and base shall depend on whether the road is on poorly-drained or well-drained soil, as determined by an engineer who has been selected and approved by the Town Board upon review of soil maps and on-site inspection. The road base and breaker run shall be Base Aggregate Dense and Breaker Run supplied and constructed in accordance with the State of Wisconsin Standard Specifications for Highway and Structure Construction Sections 301, 305, and 311. Requirements for testing within those Sections shall not apply, and the

Town Board or their selected engineer will specify the required evidence, tests, and testing frequency.

a) Roads on Well-Drained Soil.

1. 10 inches of 1.25 inch Base Aggregate Dense road base material shall be utilized.

b) Roads on Poorly-Drained Soil.

1. 10 inches of breaker run and 8 inches of 1.25 inch Base Aggregate Dense road base material shall be utilized, with geotextile or geogrid to be placed in areas under the breaker run. The geotextile and geogrid shall be in accordance with the State of Wisconsin Standard Specifications for Highway and Structure Construction Section 645, and shall be approved by the Town Board or their selected engineer.

4) Roadway Widths and Surface.

- a) There must be a 26 foot road bed with 22 feet of blacktop.
- b) Blacktop asphalt shall be a minimum of 3 ½ inches thick with proper finishing.
- c) The gravel road shall be allowed to settle for one season prior to applying asphalt blacktop, or for a period of time determined by an engineer who has been selected and approved by the Town Board.

5) Drainage. All necessary ditching and culverts for proper drainage shall be designed by the owner/developer's engineer and submitted to the Town for approval. The drainage plans shall be reviewed and approved by an engineer who has been selected and approved by the Town Board.

6) Site Stabilization.

- a) Placement of topsoil and seed on all disturbed ditch side slopes and placement of ¾ inch Base Aggregate Dense for shouldering to protect the stability of the road and to prevent erosion shall be required. This work shall be completed within 10 days after completion of the asphalt paving or as approved by the Town Board.

7) Typical Road Sections

**Figure 6-1: Typical Road Sections**

**TOWN OF RINGLE  
WELL-DRAINED SOIL  
TYPICAL SECTION**

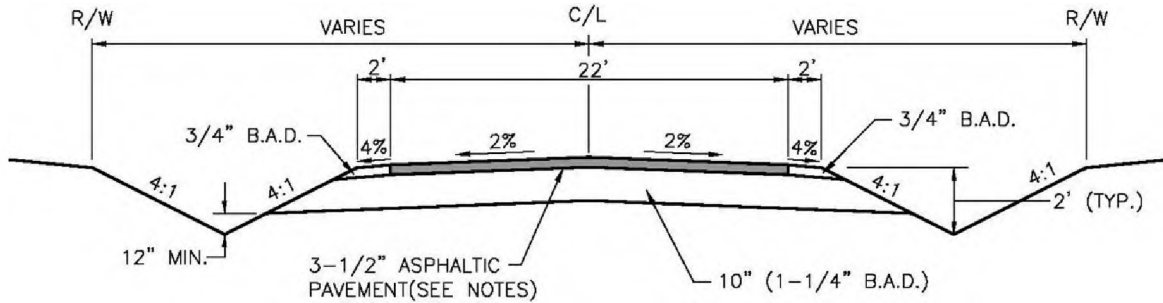

**TOWN OF RINGLE  
POORLY-DRAINED SOIL  
TYPICAL SECTION**

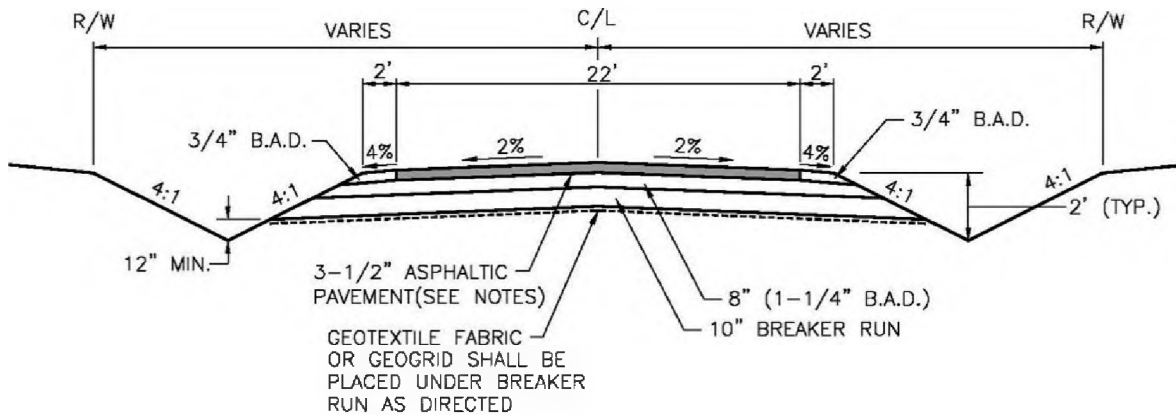

**NOTES:**

1. ASPHALTIC PAVEMENT CONSISTS OF:  
 1-3/4" BITUMINOUS BINDER COURSE  
 1-3/4" BITUMINOUS SURFACE COURSE
2. B.A.D. = BASE AGGREGATE DENSE

8) Increased Standards.

- a) The Town Board may determine that a road be constructed to specifications beyond minimum standards for reason of volume of traffic, type of traffic or soil conditions. Cost of construction beyond minimum standards shall be borne by the developer/owner where higher standards are necessitated by the owner/developer's project. In other cases, cost of construction beyond minimum standards shall be borne by the Town.

(c) Development Agreement.

- 1) Town Board shall determine if a development agreement is required.
- 2) Financial Assurance. If a development agreement is required by the Town, the following items shall be completed at the time the development agreement is executed:
  - a) File a bond, certificate of deposit, irrevocable letter of credit, or certified check with the Town, in such form as is acceptable to the Board and approved by the Town attorney.
    1. The bond, certificate of deposit, irrevocable letter of credit, or certified check shall be in amount equal to 125% of the estimated cost of the required improvements as determined by an engineer who has been selected and approved by the Town Board or by an independent consultant if deemed appropriate by the Town Board.
    2. This deposit shall guarantee that proposed improvements will be completed according to Town Specifications by the Developer or its contractors no later than 18 months from the date that the application is approved or, where staging is permitted, that each stage will be completed by the date specified in the installation and completion schedule.
    3. Such security shall be held by the Town and either released or used in the manner specified in this Ordinance.
    4. The provision of security by the applicant shall not release the applicant from its obligations under the development agreement nor prejudice the right of the Town to recover the full cost of completion of the improvements if the applicant fails to complete the same.

(d) Acceptance.

- 1) Site preparation and gravel road (road bed and base) must be completed prior to acceptance if a development agreement is required.
- 2) Upon acceptance, the Town will assume all necessary maintenance of the Town Road.

**6.02 OUTDOOR STORAGE OF JUNK, CERTAIN VEHICLES AND RECREATIONAL EQUIPMENT**

(1) DEFINITIONS

- (a) **Disassembled, Inoperable, Junked or Wrecked Motor Vehicles, Truck Bodies, Tractors, Trailers:** Motor vehicles, truck bodies, tractors or trailers in such state of physical or mechanical ruin as to be incapable of propulsion or being operated upon the public streets or highways.
- (b) **In the Open:** Land which may be viewed from public streets or adjoining property.
- (c) **Junk:** Worn out or discarded material of little or no value including, but not limited to, household appliances or parts thereof, machinery and equipment or parts thereof, vehicles or parts thereof, tools, discarded building materials or any other unsightly debris, the accumulation of which has an adverse effect upon the neighborhood or Town property values, health, safety or general welfare.
- (d) **Motor Vehicle:** As defined in § 340.01(35), Wis. Stats.
- (e) **Recreation Equipment:** Boats, canoes, boat and utility trailers, mobile homes, campers, off highway vehicles, snowmobiles, and similar recreational equipment.
- (f) **Unlicensed Motor Vehicles, Truck Bodies, Tractors or Trailers:** Motor vehicles, truck bodies, tractors or trailers which do not bear lawful current license plates.

(2) STORAGE OF INOPERABLE VEHICLES, ETC.

- (a) Restricted . No person shall accumulate, store or allow more than 2 disassembled, inoperable, junked or wrecked motor vehicles, truck bodies, tractors or trailers in the open upon any public or private property in the Town for a period exceeding 10 days.
- (b) Exceptions.
  - 1) In the Agricultural/Forestry (AG/F) and Recreational (REC) districts:
    - a) The storage of idle or operable farm equipment (i.e., vehicles, implements of husbandry, trailers, or parts thereof) typically used for agriculture or agricultural-related uses.
    - b) The storage of operable antique or collector agricultural equipment.

- 2) Legally established businesses engaged in vehicle, tractor, or trailer sales or repair may retain a maximum of 5 disassembled, inoperable, junked, or wrecked vehicles, tractors, or trailers, including vehicles under repair, in the open.
  - 3) Legally licensed and established salvage yards and solid waste facilities under the terms of this Ordinance.
- (3) STORAGE OF UNLICENSED VEHICLES, ETC.
- (a) Restricted. No person shall accumulate, store or allow more than 2 unlicensed motor vehicles, truck bodies, tractors or trailers in the open upon any public or private property in the Town for a period exceeding 10 days.
  - (b) Exceptions.
    - 1) The storage of idle or operable farm equipment (i.e., vehicles, implements of husbandry, trailers, or parts thereof) typically used for agriculture or agricultural-related uses.
    - 2) Legally established businesses engaged in the sale, repair or storage of such unlicensed vehicles, truck bodies, tractors, or trailers.
    - 3) Legally licensed and established salvage yards and solid waste facilities under the terms of this Ordinance.
    - 4) Garden tractors and mowers may be stored in the rear yard not less than 10 feet from any property line.
- (4) STORAGE OF JUNK PROHIBITED. No person, except legally licensed and established solid waste facilities and salvage yards under the terms of this Ordinance, shall accumulate, store or allow any junk outside of any building on any public or private real estate located in the Town.
- (5) STORAGE OF RECREATIONAL EQUIPMENT REGULATED. No person shall store any recreational equipment on any street right-of-way or within the front yard, including the driveway, for a period exceeding 10 days during the off-season of the subject recreational activity.



## 6.03 FIREARMS, WEAPONS, AND BOW HUNTING

### (1) DEFINITIONS

- (a) **Bow hunting:** The act of pursuing wild game during an open season as designated by the Wisconsin Department of Natural Resources with the proper license to do so with traditional bow, compound bow or crossbow equipment.
- (b) **Deer drive:** An attempt to move deer, by one or more hunters (drivers) walking together through an area, to another hunter or group of hunters who are prepared to shoot deer that are moved toward them by the drivers.
- (c) **Firearm:** Any handgun, long rifle or shotgun that uses gunpowder, black powder or black powder substitute for muzzleloaders in any manner to discharge a projectile.
- (d) **Hunting:** The act of pursuing wild game during an open season as designated by the Wisconsin Department of Natural Resources with the proper license to do so.
- (e) **Law enforcement:** Any person employed by the State of Wisconsin, or any political subdivision of this state, for the purpose of detecting and preventing crime and enforcing laws or ordinances and who is authorized to make arrests for violations of the laws or ordinances he or she is employed to enforce.
- (f) **Other weapon:** Any paintball gun, pellet gun, airsoft gun, bow and crossbow, but not firearms.
- (g) **Paintball gun:** Any handgun or long rifle designed to discharge projectiles containing a paint or ink-type substance.
- (h) **Pellet gun:** Any weapon which uses a spring mechanism or compressed air to discharge a projectile and is considered a dangerous weapon within the scope of this chapter.
- (i) **Permission of the landowner:** Written or verbal permission to discharge either firearms or other weapons on the land from the property owner.
- (j) **Practice range:** An area of land designed and designated for use of weapons for target practice where the projectile used will not leave the limits of the property on which the range is established.
- (k) **Target practice:** Utilizing firearms or other weapons to engage and fire at targets. Targets are limited to inanimate objects made of paper, plastic, vinyl, Styrofoam or any other man-made substance and are designed for use during the act of target practice.

(2) DISCHARGE REQUIREMENTS

- (a) The discharge of firearms and other weapons on or over any public roadway, or within 50 feet of the center of any roadway, is prohibited.
- (b) Any projectile discharged from a firearm or other weapon shall not travel beyond the boundary of the parcel from which it is launched.
- (c) The discharge of firearms is prohibited within 100 feet of any building or structure devoted to human occupancy without the permission of the landowner or occupant.
- (d) The discharge of firearms or other weapons shall only occur on a property for which permission of the landowner has been obtained.
- (e) The discharge of firearms and other weapons on any Town-owned land is prohibited, except lands that are described below with the following regulations:
  - 1) Tax Parcel Identification No. 072-2809-281-0999 (Brickyard Dr./State Highway 29; 30.73 acres)
  - 2) Tax Parcel Identification No. 072-2809-222-0996 (Oakley Dr.; 40 acres)
  - 3) Arrowhead Estates Park; Tax Parcel Identification No. 072-2809-195-0022 (Arrowhead Trl.; 18.29 acres)
    - a) Only bowhunting is allowed in Arrowhead Estates Park. The discharge of firearms in Arrowhead Estates Park is prohibited.
- (f) Where hunting on Town-owned land is permitted, the following regulations must be followed.
  - 1) Any cutting of trees, brush, lanes, or trails is prohibited.
  - 2) Permanent tree stands, permanent ladders or nailed-on or screw-in steps affixed to any tree are prohibited.
  - 3) Private property boundaries must not be crossed in order to pursue or retrieve game without the permission of the landowner.

- (g) Target practice with any firearm or the establishment of any outdoor practice range for any firearm is permitted only as follows:
  - 1) On a parcel having an area of five or more acres. Minimum parcel size may be reduced with site plan approval.
  - 2) Under conditions where the projectile used will not leave the parcel upon which the range is located.
  - 3) Any practice range that existed on July 16, 2013, may continue to operate as a practice range at that location notwithstanding any expansion of, or enhancement or improvement to, the practice range in accordance with §895.527, Wis. Stats.
  
- (h) Target practice with any other weapon or the establishment of any practice range for other weapons is permitted only as follows:
  - 1) On a parcel having an area of 20,000 square feet or larger.
  - 2) Where the target has a backstop constructed of such material so as to ensure that the projectile shall come to a complete stop after penetrating the target.
  - 3) Under conditions where the projectile used will not leave the parcel upon which the weapon is discharged.
  
- (i) The provisions of this chapter relating to firearms and other weapons do not apply to the following:
  - 1) Law enforcement personnel, as defined in § 165.85(2)(c), Wis. Stats., when said personnel are performing their official duties or during the conduct of an official training session.
  - 2) Indoor shooting ranges permitted under the terms of this Ordinance.
  
- (j) The discharge of other weapons inside a building with the permission of the landowner.

## **SECTION 7 SIGNS**

### **7.01 PURPOSE**

- (1) The purpose of this Section is to create the legal framework to regulate, administer, and enforce outdoor sign advertising and display. These regulations recognize the need to protect the safety and welfare of the public, the need for well-maintained and attractive sign displays within the community, the need for adequate business identification, advertising and communication, and the protection of first amendment rights of free expression.
- (2) Signs not expressly permitted as being allowed by right or by permit under this Section, by specific requirements in another portion of the Town of Ringle Code of Ordinances or other applicable law, are prohibited.
- (3) The regulations included in this Section are not intended to and do not apply to signs erected, maintained, or otherwise posted, owned, leased by, on behalf of, or as specifically directed or order by, federal, state, local governments and government agencies, in the furtherance of authorized government operations or activities within the public right-of-way.

### **7.02 INTENT**

- (1) It is the intent of this Section to permit the erection and use of signs visible from public rights-of-ways, provided the signs are in conformity with this Section, designed, constructed, installed, and maintained in such a manner that they do not endanger public safety or traffic safety and are legible, readable, and visible in the circumstances in which they are used, and respectful of the reasonable rights of other advertisers whose messages are displayed.

### **7.03 AUTHORIZATION**

- (1) These regulations authorize the use of signs visible from public rights-of-way, provided the signs are:
  - (a) Compliant with this Section.
  - (b) Designed, constructed, installed, and maintained in such a manner that they do not endanger public safety or traffic safety.
  - (c) Legible, readable, and visible in the circumstances in which they are used.
  - (d) Respectful of the reasonable rights of other advertisers whose messages are displayed.

#### **7.04 COMPLIANCE AND PERMIT REQUIRED**

- (1) No sign shall hereafter be located, erected, moved, reconstructed, extended, enlarged, converted, or structurally altered without conformance with the provisions of this Section and a sign permit, unless otherwise exempted from sign permit requirements under this Section.

#### **7.05 GENERAL REQUIREMENTS**

- (1) No signs or billboards shall be permitted in any district except as specifically permitted herein.
- (2) No sign, including all components, shall be erected within the vision clearance triangle of any road intersection.
- (3) No sign shall be illuminated by any source of light that is not shielded to prevent glare or illumination of residential property other than that of the sign owner; nor shall the glare or any light source be so directed as to impair the safety of moving vehicles.
- (4) Signs shall not resemble, imitate, or approximate the shape, size, form, or color of railroad or traffic signs, signals, or devices. Signs shall not obstruct or interfere with the effectiveness of railroad or traffic signs, signals, or devices.
- (5) Signs shall not be erected, relocated, or maintained so as to prevent free ingress to or egress from any door, window, or fire escape; and no sign shall be attached to a standpipe or fire escape.
- (6) No signs, except of a public nature normal to public right-of-ways, shall be permitted within any public right-of-way.
- (7) Flashing signs are prohibited other than official signs authorized by the appropriate granting authority of railroad or traffic control.
- (8) External illumination of signs shall be by a steady, stationary light source static in color; shielded; and directed either downward or solely at the sign.
- (9) All signs shall meet the lighting and video display requirements of Sec. 7.08(3).
- (10) No sign shall contain moving or rotating mechanical parts.

#### **7.06 SIGN PERMIT**

- (1) **PERMIT REQUIRED.** It shall be unlawful for any person to erect, construct, enlarge or structurally modify a sign or cause the same to be done in the Town of Ringle without first obtaining a sign permit for each sign from the Zoning

Administrator as required by this Section. Permits shall not be required for the following:

- (a) A change of copy of any sign, nor for the repainting, cleaning and other normal maintenance and repair of the sign and sign structure.
  - (b) Exempted signs as listed below.
- (2) APPLICATION FOR A PERMIT. Application for a permit shall be filed with the Zoning Administrator upon forms provided by the Town, and shall contain or have attached thereto the following information:
- (a) Location: Name, address, and telephone number of the applicant; location of building, structure, or lot to which or upon which the sign is to be attached or erected.
  - (b) Responsible Parties: Name of person, firm, corporation, or association erecting the sign.
  - (c) Consent: Written consent of the owner or lessee of the building, structure, or land to which or upon which the sign is to be affixed.
  - (d) Elevation: A scaled elevation drawing of such sign indicating the dimensions, the materials to be used, the type of illumination, if any, and the method of construction and attachment.
  - (e) Plan: A scaled site plan drawing indicating the location and position of such sign in relation to nearby buildings or structures.
  - (f) Other Permits: Copies of any other permits required and issued for said sign.
  - (g) Additional Information: Additional information as may be required by the Town Planning & Zoning Committee.
  - (h) Surety: An applicant, before the permit is granted, may be required to execute a surety bond in a sum to be fixed by the Town Board, and it shall be of a form and type approved by the Town Attorney, indemnifying the municipality against all loss, cost, damages, or expense incurred or sustained by or recovered against the municipality by reason of the erection, construction, or maintenance of such sign.
- (3) PERMIT REVIEW.
- (a) The Zoning Administrator shall issue a permit for the erection, structural alteration, enlargement or relocation of a sign when the permit application is properly made, all appropriate fees have been made, and the sign complies

with the appropriate laws and regulations. Submittal of a complete application and required application fee does not guarantee approval/issuance of the permit.

- (b) If the sign permit is denied, the Zoning Administrator shall provide written notice of the denial to the applicant, together with a brief statement of the reasons for the denial.
- (c) A sign permit shall become null and void, if work authorized under the permit has not been completed within six (6) months of the date of issuance.
- (4) **PERMIT FEE.** All permit applications shall be accompanied by a fee established by the Town of Ringle Board of Supervisors. Any costs associated with a third-party consultant hired by the Town for review of an application (e.g., engineering, architectural, legal, etc.) may be the responsibility of the applicant.
- (5) **INDEMNIFICATION.** By applying for a sign permit, all persons engaged in the erection and maintenance of the sign, including the applicant, shall indemnify, defend, and hold harmless the Town, its officers, agents, and employees from and against any and all third party claims arising out of the installation or maintenance of the sign, or otherwise related to the sign.

#### **7.07 EXEMPTIONS**

- (1) The following signs are permitted in all zoning districts without a permit subject to the following regulations:
  - (a) Municipally erected traffic and parking signs.
  - (b) Government and other official signs.
  - (c) Official notices posted by public officers or employers in the performance of their duties.
  - (d) Signs located within the interior of any building or structure which are not visible from the public right-of-way.
  - (e) Seasonal, holiday, or other temporary decorations.
  - (f) Flags that have been adopted by the federal, state, or local government.
  - (g) Signs and sign supporting structures that cannot be seen from a public or private roadway right-of-way, public property, or navigable water.
  - (h) Truck, bus, trailer or other vehicles, while operating in the normal course of business which is not primarily the display of signs.

- (i) A sign carried by a person.
- (j) Real Estate Signs not exceeding sixteen (16) square feet in area which advertise the sale, rental, or lease of the premises upon which said signs are temporarily located. Real Estate signs shall not be illuminated. Larger signs require a sign permit.
- (k) Name, home occupation, and warning signs not exceeding sixteen (16) square feet in area located on the premises. Home occupation signs shall not be illuminated.
- (l) Bulletin boards for public, charitable or religious institutions not exceeding thirty-two (32) square feet in area located on the premises.
- (m) Memorial signs, tablets, names of buildings, and date of erection when cut into any masonry surface or when constructed of metal and affixed flat against a structure.
- (n) Temporary signs or banners up to a maximum of six (6) months.

## **7.08 STANDARDS**

- (1) CONSTRUCTION, MAINTENANCE, AND REPAIR STANDARDS.
  - (a) All signs shall be maintained in a safe condition and good repair at all times.
  - (b) The construction, erection, safety and maintenance of all signs shall comply with all applicable town standards and regulations including but not limited to applicable state fire, building, and electrical codes.
  - (c) Permanent signs shall be fabricated on and of materials that are of good quality and good durability. Wood shall be treated to prevent deterioration. Letters, figures, and characters shall be securely attached to the sign structure.
  - (d) Temporary signs shall be durable and weather-resistant and fastened or anchored sufficiently, whether attached to the building or positioned in the ground.
- (2) MEASUREMENT STANDARDS.
  - (a) Sign Face Area.
    - 1) Sign area shall be measured as the entire surface area of a sign display face upon which copy could be placed; or, if no background or frame, the total area of the smallest rectangle or rectangles that can encompass all



words, letters, figures, emblems, and any other element of the sign's message. When a sign has more than one display face, the combined surface area of all display faces that can be viewed simultaneously shall be considered the sign face area.

- 2) Two-face signs. Sign area of two-face signs shall be measured only on one face of the sign, except that when the interior angle formed by the faces is greater than 45 degrees, or the faces are greater than 18 inches apart, all faces of such sign shall be considered in calculating the sign area.

(b) Sign Height.

- 1) The sign height shall be the vertical distance measured from the grade at the base of the sign structure to the highest point of such sign or sign structure.

(3) ILLUMINATION AND VIDEO DISPLAY.

- (a) No sign shall be illuminated by any source of light that is not shielded to prevent glare or illumination of residential property other than that of the sign owner; nor shall the glare or any light source be so directed as to impair the safety of moving vehicles.
- (b) Internal illumination, including neon lighting, must be static in intensity and color.
- (c) External illumination shall be by a steady, stationary light source static in color; shielded; and directed either downward or solely at the sign.
- (d) Flashing signs are prohibited other than official signs authorized by the appropriate granting authority of railroad or traffic control.
- (e) Video display signs may be incorporated within or used as signs in compliance with the following restrictions:
  - 1) The sign must be located on the site of the use identified or advertised by the sign.
  - 2) Video display signs shall only be permitted in commercial, industrial or agricultural zoning districts.
  - 3) The sign area of the video display signs shall be no greater than 50 percent of the attached or free-standing sign area.
  - 4) Video display signs shall not be utilized as a stand-alone sign and shall be incorporated into or attached to a primary business/quasi-public

identification sign so that separation between the two signs is limited to one foot.

- 5) The sign must not exceed a maximum illumination of 5,000 nits (candles per square meter) during daylight hours and a maximum of 500 nits (candles per square meter) between dusk to dawn as measured from the sign's face at maximum brightness.
- 6) Video display signs must have an automatic dimmer control to produce a distinct illumination change from a higher illumination level to a lower illumination level for the time period of one-half hour before sunset and one half-hour after sunrise.
- 7) No sign shall conflict with the visibility of any traffic signal as determined by a qualified traffic engineer.
- 8) Video display sign messages shall not change more than six times per minute.
- 9) Messages shall not repeat in intervals of less than 4 seconds nor have a single animation that last longer than 10 seconds. Individual static messages may last longer than ten seconds.
- 10) Audio speakers or any form of pyrotechnics are prohibited in association with video display signs.
- 11) No video display sign shall be located within 100 feet or directly face a residentially-zoned property.
- 12) No video display sign shall be located within 100 feet of another video display sign.

(4) SETBACKS

- (a) All signs, including all components, shall be set back a minimum of 5 feet from any property line or right-of-way line.
- (b) No sign, including all components, shall be erected within the vision clearance triangle of any road intersection.

(5) ABANDONED SIGNS.

- (a) No sign in the Town shall be abandoned by the owner. Any sign not properly and reasonable maintained by the owner shall be removed by the owner within 30 days of receipt of a written notice from the Town. Failure to remove an abandoned sign, plus any foundation, within that period shall cause the Town

to remove the sign after an additional 10-day written notice is mailed to the owner. Removal expenses will be charged to the owner of the sign or to the owner of the land where the sign is located. In the event removal costs are unpaid, they may be charged against the property as a special charge.

**7.09 SIGNS PERMITTED IN AGRICULTURAL/FORESTRY (AG/F), RECREATIONAL (REC), CONCENTRATED MIXED USE (CMU), GENERAL COMMERCIAL(GC) AND INTENSIVE/LIGHT INDUSTRIAL (IC/LI) DISTRICTS**

- (1) TOTAL SIGNAGE. Each individual business is limited to a total of two (2) signs. This includes wall signs, projecting signs, freestanding signs, and roof signs, but excludes interior window signs, awning signs, portable signs, and off-premise/directional signs.
- (2) SIGN TYPES:
  - (a) Wall signs, subject to the following:
    - 1) Wall signs include lettering and images painted directly onto the exterior surface of the building.
    - 2) Wall signs shall not extend more than 12 inches outside a building's wall surface.
    - 3) Wall signs shall not exceed 300 square feet in area for each sign.
    - 4) Wall signs shall not extend above the building's roof line.
  - (b) Projecting signs, subject to the following:
    - 1) Projecting signs fastened to, suspended from, or supported by structures shall not extend more than 6 feet into any required yard and shall not be less than 10 feet from all side lot lines.
    - 2) Projecting signs shall not extend above the building's roof line.
    - 3) Projecting signs shall not be less than 10 feet above any sidewalk or pedestrian walkway, nor less than 15 feet above any driveway or alley.
    - 4) Projecting signs shall not exceed 40 square feet in area per sign face.

(c) Freestanding signs, subject to the following:

- 1) Freestanding signs shall not exceed 200 square feet in area.
- 2) Freestanding signs shall not exceed 25 feet in height.

(d) Roof Signs, subject to the following:

- 1) No more than one roof sign is permissible on any lot.
- 2) Roof sign shall not exceed 10 feet in height above the roof or parapet.
- 3) Roof sign shall not extend beyond the building upon which it is located.
- 4) Roof sign shall not exceed 200 square feet in area.

(e) Window signs, subject to the following:

- 1) Window signs shall be placed only on the inside of commercial buildings.
- 2) Window signs shall not exceed 25% of the glass area of the pane upon which the sign is displayed.

(f) Awning signs, subject to the following:

- 1) Awning signs shall be applied only on the surface of the awning and limited to no more than 25% of the awning surface area.

(g) Portable signs, subject to the following:

- 1) Portable signs shall not exceed 16 square feet in area.
- 2) Portable signs shall not exceed 6 feet in height.

## **7.10 SIGNS PERMITTED IN RESIDENTIAL-LARGE LOT (R-1) AND RESIDENTIAL-SMALL LOT (R-2) DISTRICTS**

(1) SIGN TYPES:

(a) Subdivision entry signs, subject to the following:

- 1) Subdivision entry signs shall contain only the name of the subdivision or development.
- 2) Subdivision entry signs shall be placed outside of the road right-of-way.

- 3) At any entrance to a residential subdivision, there shall be no more than 2 subdivision entry signs identifying such subdivision.
- 4) Subdivision entry signs shall not exceed 32 square feet in area.
- 5) Subdivision entry signs shall not exceed 7 feet in height.

(b) Home Occupation signs, subject to the following:

- 1) A maximum of 1 wall sign advertising a home occupation shall be permitted on a lot.
- 2) Home occupation signs shall be located on the premises in which the home occupation is established.
- 3) Home occupation signs shall not exceed 16 square feet in area.
- 4) Home occupation signs shall not extend above the building's roof line.
- 5) Home occupation signs shall not be illuminated.

#### **7.11 ELECTION CAMPAIGN SIGNS**

- (1) Election campaign signs may be allowed in any district without a permit provided that permission shall be obtained from the property owner, renter or lessee; and provided that such sign shall not be erected prior to the election campaign period as defined in Sec. 12.04, Wis. Stats., and removed within seven (7) days following the election.

#### **7.12 NONCONFORMING SIGNS**

- (1) Any sign located in the Town of Ringle as of the date of adoption or amendment of this Section that does not conform to the provisions of this Section as adopted or amended is a legal, nonconforming sign if the sign was legally constructed prior to the date of adoption or amendment of this Section.
- (2) A sign loses its legal, nonconforming status if one of the following occurs:
  - (a) The sign is structurally altered in any way (other than normal maintenance and repair) that makes the sign less compliant with the requirements of this Section than it was before the alteration.
  - (b) The sign is relocated.
  - (c) The sign is abandoned.

- (d) The permitted or conditional use associated with the sign changes.
- (3) A nonconforming sign can be reconstructed to its former state if it is destroyed by wind, vandalism, fire, ice, or flood.

**7.13 SIGN DEFINITIONS.** For the purposes of clarification, discussion and permit review, the following definitions shall apply to this Ordinance.

- (1) **Animated sign:** Any sign that utilizes movement, change of lighting, or electronic lettering to depict action, create messages, or special effects.
- (2) **Awning:** A roof-like shelter projecting from and supported wholly by the exterior wall of a building and constructed of non-rigid materials on a supporting framework. See the following graphic.
- (3) **Awning sign:** A sign incorporated into or attached to an awning or canopy.

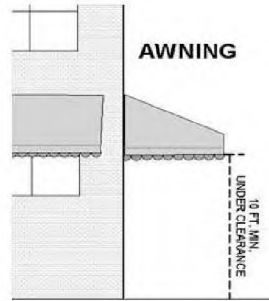

- (4) **Billboard sign:** A sign which directs attention to a business, product, service, or activity not conducted, sold, or offered upon the premises where such sign is located. Also termed "off-premises advertising sign."
- (5) **Bulletin board sign:** A permanently anchored sign with changeable letters used to indicate upcoming events or programs, typically in association with a church, park, school, or other institutional building.
- (6) **Business flags:** A wall-mounted flag made of a durable fabric that contains graphics limited to business name, logo and advertising used to promote products and services for the premises.
- (7) **Business sign:** A sign that identifies the business, product, service, or activity that is sold or offered upon the premises where such sign is located. A business sign may be a wall sign, a free-standing sign, marquee sign, projecting sign, or other sign type.

- (8) **Canopy:** A structure, other than an awning, made of non-rigid material on a supporting framework attached to a building and supported by the ground. See the following graphic.

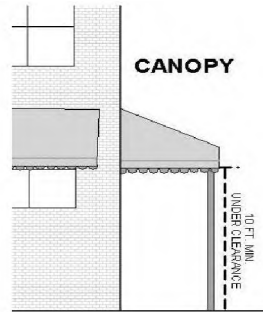

- (9) **Changeable copy sign:** Any on premise sign or portion thereof with characters, letters, or illustrations that can be changed or rearranged without altering the face or the surface of the sign. Such sign shall not include any sign considered to be an animated sign. A readerboard sign is to be considered a changeable copy sign.
- (10) **Directional sign:** A sign which serves primarily to direct people to the location of a place, area, or activity.
- (11) **Directory sign:** A sign which serves as a common or collective identification for a group of businesses or occupations operating on the same property or planned development. See the following graphic.



- (12) **Flags:** Flags, symbols, or crests of nations or any organization of nations, states, and cities, fraternal, religious, and civic institutions.
- (13) **Flashing sign:** An illuminated sign, the illumination of which is not kept constant in intensity at all times when in use.
- (14) **Freestanding sign:** Any sign supported by uprights, poles, or braces placed upon the ground or a sign placed directly on the ground and not attached to any building. Freestanding signs include, but are not limited to, monument, pylon, and portable signs.
- (15) **Illuminated sign:** A sign having characters, letters, figures, designs, or outlines illuminated by electric lighting or luminous tubes as a part of the sign.

- (16) **Logo:** A name, symbol, or trademark of a company or establishment encompassed in one individual graphic.
- (17) **Marquee sign:** A permanent roof-like structure or canopy of rigid materials supported by and extended from the façade of a building.
- (18) **Monument sign:** A type of freestanding sign where at least three-fourths of the horizontal length of the sign is permanently fixed to a decorative base, the full horizontal length of which is anchored to the ground. See the following graphic.

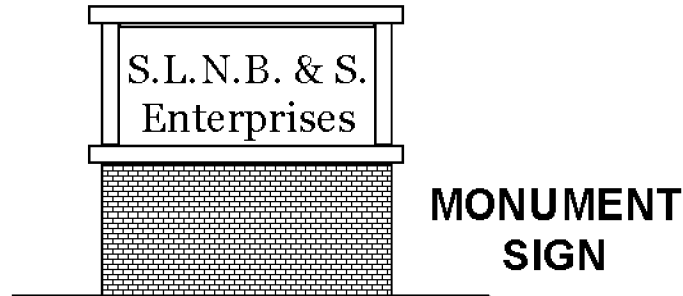

- (19) **Multiple message signs:** A "billboard sign" or "off premise advertising sign" which automatically changes message or copy electronically or by the movement or rotation of panels or slats. This includes, but is not necessarily limited to, signs known as tri-vision billboards, electronic variable message signs, and digital billboards.
- (20) **Nameplate sign:** A sign which states the name and/or address of the occupant of the lot where the sign is located.
- (21) **Nit:** A luminance unit equal to one candle per square meter measured perpendicular to the rays from the source.
- (22) **Political sign:** A sign which announces a candidate as seeking public political office and/or which conveys political issues and expressions of noncommercial individual speech.
- (23) **Portable sign:** A type of temporary sign designed to be moved from one location to another and which is not permanently attached to the ground, sales display device, or structure. Portable signs include, but are not limited to:
  - (a) Signs with chassis or support constructed without wheels.
  - (b) Signs designed to be transported by trailer or wheels.
  - (c) Menu- and sandwich-board signs.



(d) Signs mounted or painted on a vehicle for advertising purposes, parked and visible from the public right-of-way (except for signs identifying the related business when the vehicle is being used in the normal day-to-day operations of that business).

(24) **Projecting sign:** A sign which is attached to a building or structure and extends more than 18 inches beyond the line of the building or structure or that part of the building or structure to which it is attached. See the following graphic.

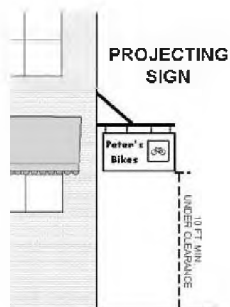

(25) **Pylon sign:** A type of freestanding sign erected on shafts, posts, walls, or piers that are solidly affixed to the ground and not attached to a building. A pylon sign shall be considered as one sign though it may have two or more faces. See the following graphic.

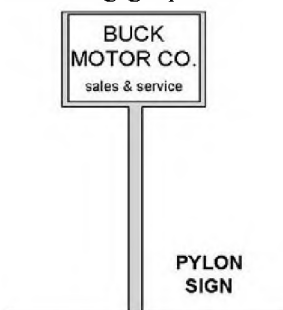

(26) **Revolving or rotating sign:** Any sign or portion of a sign which moves in a revolving 360-degree motion.

(27) **Roof sign:** A sign which is mounted on the roof of a building or which projects above the top of the wall of a building with a flat, gambrel, gable, or hip roof or the deck line of a building with a mansard roof.

(28) **Sandwich board:** A movable temporary sign that is self-supporting, A-shaped and freestanding with only two visible sides that are situated adjacent to a business, typically on a sidewalk.

(29) **Sign:** A name, identification, description, display, illustration, or device which is affixed to or mounted on a building, a structure, or the ground and which directs attention to an object, product, place, activity, person, institution, organization, or business. The term "sign" includes sign supports.

- (30) **Sign area:** See Sec. 7.08(2)(a).
- (31) **Sign face:** The surface of the sign upon, against, or through which the message of the sign is exhibited.
- (32) **Sign structure:** A structure, including the supports, uprights, bracing, and framework that supports or is capable of supporting a sign.
- (33) **Temporary sign:** Any sign, balloon, banner, blimp, flag, free-standing sign, pennant, poster, readerboard, or advertising display which is intended to be displayed for a limited period of time.
- (34) **Video display sign:** An on premise sign that changes its message or background in a manner or method of display characterized by motion or pictorial imagery, which may or may not include text and depicts action or a special effect to imitate movement; the presentation of pictorials or graphics displayed in a progression of frames, which give the illusion of motion, including, but not limited to, the illusion of moving objects, moving patterns or band of light, or expanding or contracting shapes.
- (35) **Wall sign:** A sign which is attached to or painted on the wall of a building, with the sign face in a plane parallel to the plane of the building wall and extending no more than 18 inches from the face of such wall. See the following graphic.

**WALL SIGN**

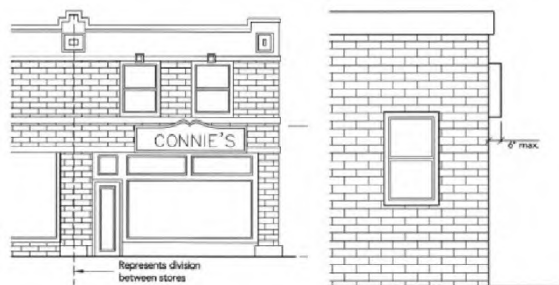

- (36) **Window sign:** Any sign, lettering, pictures, symbols, or combination thereof designed to communicate information about a business, product, service, or activity which is placed upon a window and meant to be visible from the exterior of the building. See the following graphic.

**WINDOW SIGN**



## SECTION 8 MOBILE TOWER SITING REGULATIONS

**8.01 PURPOSE.** The purpose of this Section is to regulate: (1) the siting and construction of any new mobile service support structure and facilities; (2) with regard to a class 1 collocation, the substantial modification of an existing support structure and mobile service facilities; and (3) with regard to a class 2 collocation, collocation on an existing support structure which does not require the substantial modification of an existing support structure and mobile service facilities.

**8.02 DEFINITIONS IN THIS SECTION.** Definitions in this Section are intended to be consistent with §66.0404, Wisconsin Statutes.

- (1) **Antenna:** Communications equipment that transmits and receives electromagnetic radio signals and is used in the provision of mobile services.
- (2) **Application:** An application for a permit under this Section to engage in an activity specified in sub. (2) (a) or a class 2 collocation.
- (3) **Building permit:** A permit issued by a political subdivision that authorizes an applicant to conduct construction activity that is consistent with the political subdivision's building code.
- (4) **Class 1 collocation:** The placement of a new mobile service facility on an existing support structure such that the owner of the facility does not need to construct a free standing support structure for the facility but does need to engage in substantial modification.
- (5) **Class 2 collocation:** The placement of a new mobile service facility on an existing support structure such that the owner of the facility does not need to construct a free standing support structure for the facility or engage in substantial modification.
- (6) **Collocation:** Class 1 or class 2 collocation or both.
- (7) **Distributed antenna system:** A network of spatially separated antenna nodes that is connected to a common source via a transport medium and that provides mobile service within a geographic area or structure.
- (8) **Equipment compound:** An area surrounding or adjacent to the base of an existing support structure within which is located mobile service facilities.
- (9) **Existing structure:** A support structure that exists at the time a request for permission to place mobile service facilities on a support structure is filed with a political subdivision.

- (10) **Fall zone:** The area over which a mobile support structure is designed to collapse.
- (11) **Mobile service:** The meaning given in 47 USC 153 (33).
- (12) **Mobile service facility:** The set of equipment and network components, including antennas, transmitters, receivers, base stations, power supplies, cabling, and associated equipment, that is necessary to provide mobile service to a discrete geographic area, but does not include the underlying support structure.
- (13) **Mobile service provider:** A person who provides mobile service.
- (14) **Mobile service support structure:** A freestanding structure that is designed to support a mobile service facility.
- (15) **Permit:** A permit, other than a building permit, or approval issued by a political subdivision which authorizes any of the following activities by an applicant:
  - (a) A class 1 collocation.
  - (b) A class 2 collocation.
  - (c) The construction of a mobile service support structure.
- (16) **Political subdivision:** A city, village, town, or county.
- (17) **Public utility:** The meaning given in §196.01 (5), Wis. Stats.
- (18) **Search ring:** A shape drawn on a map to indicate the general area within which a mobile service support structure should be located to meet radio frequency engineering requirements, taking into account other factors including topography and the demographics of the service area.
- (19) **Substantial modification:** The modification of a mobile service support structure, including the mounting of an antenna on such a structure, that does any of the following:
  - (a) For structures with an overall height of 200 feet or less, increases the overall height of the structure by more than 20 feet.
  - (b) For structures with an overall height of more than 200 feet, increases the overall height of the structure by 10 percent or more.
  - (c) Measured at the level of the appurtenance added to the structure as a result of the modification, increases the width of the support structure by 20 feet or more, unless a larger area is necessary for collocation.
  - (d) Increases the square footage of an existing equipment compound to a total area of more than 2,500 square feet.
- (20) **Support structure:** An existing or new structure that supports or can support a mobile service facility, including a mobile service support structure, utility pole, water tower, building, or other structure.

- (21) **Utility pole:** A structure owned or operated by an alternative telecommunications utility, as defined in §196.01 (1d), Wis. Stats.; public utility, as defined in §196.01 (5), Wis. Stats.; telecommunications utility, as defined in §196.01 (10), Wis. Stats.; political subdivision; or cooperative association organized under Ch. 185, Wis. Stats.; and that is designed specifically for and used to carry lines, cables, or wires for telecommunications service, as defined in §182.017 (1g) (cq), Wis. Stats.; for video service, as defined in §66.0420 (2) (y), Wis. Stats.; for electricity; or to provide light.

### **8.03 SITING AND CONSTRUCTION OF ANY NEW MOBILE SERVICE SUPPORT STRUCTURE AND FACILITIES**

#### **(1) APPLICATION PROCESS**

- (a) A conditional use permit is required for the siting and construction of any new mobile service support structure and facilities. The siting and construction of any new mobile service support structure and facilities is a conditional use in the town obtainable with this permit.
- (b) A written permit application must be completed by any applicant and submitted to the town. The application must contain the following information:
- 1) The name and business address of, and the contact individual for, the applicant.
  - 2) The location of the proposed or affected support structure, including a Site Plan in a graphic scale not greater than 1 inch=200 feet, showing at a minimum the following: (a) the location of each proposed or affected support structure, parking area, driveway, and other improvement on the lot with the distance from each lot line indicated; (b) the location of the minimum setback lines; (c) the location of all nonparticipating dwelling units and the distance from each proposed or affected support structure indicated; (d) the location of existing public and private roads and highways adjacent to the lot. Two (2) copies of the Site Plan shall accompany the application.
  - 3) The location of the proposed mobile service facility shall also be included on the Site Plan under (b) 2) above.
  - 4) A construction plan which describes the proposed mobile service support structure and the equipment and network components, including antennas, transmitters, receivers, base stations, power supplies, cabling, and related equipment to be placed on or around the new mobile service support structure.

- 5) An explanation as to why the applicant chose the proposed location and why the applicant did not choose collocation, including a sworn statement from an individual who has responsibility over the placement of the mobile service support structure attesting that collocation within the applicant's search ring would not result in the same mobile service functionality, coverage, and capacity; is technically infeasible; or is economically burdensome to the mobile service provider.
- (c) A permit application will be provided by the town upon request to any applicant.
  - (d) If an applicant submits to the town an application for a permit to engage in an activity described in this Sec. 8.03 which contains all of the information required under this Section, the town shall consider the application complete. If the town does not believe that the application is complete, the town shall notify the applicant in writing, within 10 days of receiving the application, that the application is not complete. The written notification shall specify in detail the required information that was incomplete. An applicant may resubmit an application as often as necessary until it is complete.
  - (e) Within 90 days of its receipt of complete application, the town shall complete all of the following or the applicant may consider the application approved, except that the applicant and the town may agree in writing to an extension of the 90 day period:
    - 1) Review the application to determine whether it complies with all applicable aspects of the town's building code and, subject to the limitations in this Section, zoning ordinances.
    - 2) Make a final decision whether to approve or disapprove the application.
    - 3) Notify the applicant, in writing, of its final decision.
    - 4) If the decision is to disapprove the application, include with the written notification substantial evidence which supports the decision.
  - (f) The town may disapprove an application if an applicant refuses to evaluate the feasibility of collocation within the applicant's search ring and provide the sworn statement described under Sec. 8.03 (1) (b) 5).
  - (g) If an applicant provides the town with an engineering certification showing that a mobile service support structure, or an existing structure, is designed to collapse within a smaller area than the setback or fall zone area required in a zoning ordinance, that zoning ordinance does not apply to such a structure unless the town provides the applicant with substantial evidence that the engineering certification is flawed.

- (h) Fee. All permit applications shall be accompanied by a fee established by the Town of Ringle Board of Supervisors. (Note: Maximum fee shall not exceed limitations established per §66.0404, Wis. Stats.).

## **8.04 CLASS 1 COLLOCATION**

### **(1) APPLICATION PROCESS**

- (a) A conditional use permit is required for a class 1 collocation. A class 1 collocation is a conditional use in the town obtainable with this permit.
- (b) A written permit application must be completed by any applicant and submitted to the town. The application must contain the following information:
  - 1) The name and business address of, and the contact individual for, the applicant
  - 2) The location of the proposed or affected support structure, including all requirements of Sec. 8.03 (1) (b) 2).
  - 3) The location of the proposed mobile service facility shall also be included on the Site Plan pursuant to (b) 2) above.
  - 4) A construction plan which describes the proposed modifications to the support structure and the equipment and network components, including antennas, transmitters, receivers, base stations, power supplies, cabling, and related equipment associated with the proposed modifications.
- (c) A permit application will be provided by the town upon request to any applicant.
- (d) If an applicant submits to the town an application for a permit to engage in an activity described in this Sec. 8.04, which contains all of the information required under this Section, the town shall consider the application complete. If the town does not believe that the application is complete, the town shall notify the applicant in writing, within 10 days of receiving the application, that the application is not complete. The written notification shall specify in detail the required information that was incomplete. An applicant may resubmit an application as often as necessary until it is complete.
- (e) Within 90 days of its receipt of a complete application, the town shall complete all of the following or the applicant may consider the application

approved, except that the applicant and the town may agree in writing to an extension of the 90 day period:

- 1) Review the application to determine whether it complies with all applicable aspects of the town's building code and, subject to the limitations in this Section, zoning ordinances.
  - 2) Make a final decision whether to approve or disapprove the application.
  - 3) Notify the applicant, in writing, of its final decision.
  - 4) If the decision is to disapprove the application, include with the written notification substantial evidence which supports the decision.
- (f) If an applicant provides the town with an engineering certification showing that a mobile service support structure, or an existing structure, is designed to collapse within a smaller area than the setback or fall zone area required in a zoning ordinance, that zoning ordinance does not apply to such a structure unless the town provides the applicant with substantial evidence that the engineering certification is flawed.
- (g) Fee. All permit applications shall be accompanied by a fee established by the Town of Ringle Board of Supervisors. (Note: Maximum fee shall not exceed limitations established per §66.0404, Wis. Stats.).

## **8.05 CLASS 2 COLLOCATION**

### **(1) APPLICATION PROCESS**

- (a) A zoning permit is required for a class 2 collocation. A class 2 collocation is a permitted use in the town but still requires the issuance of the zoning permit.
- (b) A written permit application must be completed by any applicant and submitted to the town. The application must contain the following information:
  - 1) The name and business address of, and the contact individual for, the applicant.
  - 2) The location of the proposed or affected support structure, including all requirements of Sec. 8.03 (1) (b) 2).
  - 3) The location of the proposed mobile service facility shall also be included on the Site Plan pursuant to (b) 2) above.



- (c) A permit application will be provided by the town upon request to any applicant.
- (d) A class 2 collocation is subject to the same requirements for the issuance of a building permit to which any other type of commercial development or land use development is subject under the town ordinances.
- (e) If an applicant submits to the town an application for a permit to engage in an activity described in this Sec. 8.05, which contains all of the information required under this Section, the town shall consider the application complete. If any of the required information is not in the application, the town shall notify the applicant in writing, within 5 days of receiving the application, that the application is not complete. The written notification shall specify in detail the required information that was incomplete. An applicant may resubmit an application as often as necessary until it is complete.
- (f) Within 45 days of its receipt of a complete application, the town shall complete all of the following or the applicant may consider the application approved, except that the applicant and the town may agree in writing to an extension of the 45 day period:
  - 1) Make a final decision whether to approve or disapprove the application.
  - 2) Notify the applicant, in writing, of its final decision.
  - 3) If the application is approved, issue the applicant the relevant permit.
  - 4) If the decision is to disapprove the application, include with the written notification substantial evidence which supports the decision.
- (g) Fee. All permit applications shall be accompanied by a fee established by the Town of Ringle Board of Supervisors. (Note: Maximum fee shall not exceed limitations established per §66.0404, Wis. Stats.).

**8.06 REQUIREMENTS.** The following requirements apply to all permits issued under this Section.

- (1) **SURETY FOR DECOMMISSIONING.** For any conditional use permit issued under this Section, the Town Board may require an applicant to provide a surety in the amount of up to \$20,000 prior to the issuance of a permit and maintain the surety as current throughout the duration of the permit to insure the performance of permittee and owner of decommissioning under Sec. 8.06 (2). Such amount is deemed to be completely neutral, nondiscriminatory, and commensurate with the historical record for surety requirements for other facilities and structures in the town which fall into disuse.

- (2) DECOMMISSIONING. Notwithstanding the fact that a permit granted under this Ordinance is not limited in duration, a mobile service support structure and mobile service facilities out of service for a continuous six (6) month period are deemed abandoned. In that case, the Zoning Administration may issue a Notice of Abandonment to the permittee or owner. The owner shall remove the mobile service structure and mobile service facilities within 90 days of the Notice of Abandonment. Such removal includes, but is not limited to, removal of all above ground structures and improvements; removal of all foundation, pads, underground electrical wires, fencing, and reclaim the site to a depth of four (4) feet below the surface of the ground. This decommissioning shall be secured by a surety pursuant to Sec. 8.06 (1).
- (3) CONSTRUCTION. Any construction authorized under this Ordinance shall comply with the applicable federal, state, county and town building codes.
- (4) LIGHTING. Any lighting of a structure shall be designed to cause the least disturbance.
- (5) SPACE FOR TOWN. The town board may require as a condition of approval the agreement of the facility owner to provide space on or near the structure for the use of or by the town at the fair market value rate, except as prohibited in Sec. 66.0404 (4)(w), Wis. Stats.
- (6) SITE SECURITY AND ACCESS. Any structure or facility site shall be secured with a chain link fence at least eight (8) feet high, with three strands of barbed wire on top, with a locked gate so as not to be accessible by the general public. Only signs pertaining to equipment information, identity of operator or warning shall be located on any structure or facility. A minimum of two (2) parking spaces and a driveway constructed pursuant to the requirements of Section 5 of this Ordinance shall be provided at a facility site.
- (7) SETBACK/FALL ZONE REQUIREMENTS.
  - (a) The setback or fall zone requirement for mobile service support structures is the height of the structure.
  - (b) If an applicant provides the Town with an engineering certification showing that a mobile service support structure, or an existing structure, is designed to collapse within a smaller area than the setback or fall zone area required above, that setback or fall zone does not apply to such a structure unless the Town provides the applicant with substantial evidence that the engineering certification is flawed.

**8.07 APPEAL**

- (1) Any party aggrieved by the final decision of the town board under Sec. 8.03, 8.04, or 8.05 may bring an action in Marathon County, Wisconsin circuit court.

**8.08 SEVERABILITY**

- (1) The provisions of this Ordinance are severable. If any provision of this Ordinance or its application to any person or circumstance is held invalid by a court of competent jurisdiction, such holding shall not affect other provisions or applications of this Ordinance that can be given effect without the invalid provision or application.

## SECTION 9 NONCONFORMING

- 9.01 APPLICABILITY.** The provisions of this Section shall apply to uses, structures, and lots that legally existed as of the effective date of this Ordinance, but that become nonconforming as the result of application of this Ordinance to them or from reclassification of the property under any subsequent amendments to this Ordinance.
- 9.02 PURPOSE.** It is the general policy of the Town of Ringle to allow nonconforming uses, structures, or lots to continue to exist and to be put to productive use. However, it is also the general policy of the town to bring as many aspects of such nonconformities into conformance with this Ordinance as is reasonably practicable, all subject to the limitations of this Section. The limitations of this Section are intended to recognize the interests of property owners in continuing to use their property but to reasonably control expansions, reestablishment of discontinued uses, and the reestablishment of nonconforming buildings and structures that have been substantially destroyed.
- 9.03 AUTHORITY TO CONTINUE.** Nonconformities shall be allowed to continue in accordance with the requirements of this Section.
- 9.04 REPAIRS AND MAINTENANCE.** Repairs and normal maintenance required to keep nonconforming uses and structures in a safe condition shall be permitted, provided that no alterations shall be made except those allowed by this Section or required by law or ordinance.
- 9.05 NONCONFORMING USES.** Nonconforming uses shall be subject to the following standards:
- (1) ENLARGEMENT AND EXPANSION.
    - (a) A nonconforming use may be enlarged, increased, or extended beyond the area it occupied as of the effective date of this Ordinance, provided that the expansion is approved by the Town Board after a public hearing before the Planning & Zoning Committee.
    - (b) All enlargements, increases, and extensions of a nonconforming use shall not exceed 50% of the area that the nonconforming use occupied as of the effective date of this Ordinance.
  - (2) DISCONTINUANCE. If a nonconforming use is discontinued for a period of 12 consecutive months or more, any use of the property thereafter shall be in conformance with regulations and provisions set by this Ordinance for the district in which such property is located.

(3) **DAMAGE OR DESTRUCTION.**

- (a) If any structure that is devoted in whole or in part to a nonconforming use is damaged or destroyed by violent wind, vandalism, fire, flood, ice, snow, mold, infestation, or other calamity, the structure and nonconforming use may be restored or replaced to the size, location, and use that it had immediately before the damage or destruction occurred, subject to building code and other applicable requirements.

**9.06 NONCONFORMING STRUCTURES**

- (1) Nonconforming Structures may be repaired, maintained, renovated, rebuilt, or remodeled, subject to building code and other applicable requirements.
- (2) Additions to or extensions of nonconforming structures beyond the existing building envelope are permitted provided that such additions or extensions comply with all the provisions of this Ordinance.
- (3) A nonconforming structure that is damaged or destroyed by violent wind, vandalism, fire, flood, ice, snow, mold, infestation, or other calamity may be restored or replaced to the size, location, and use that it had immediately before the damage or destruction occurred, subject to building code and other applicable requirements.
- (a) The size of the structure may be larger than the size immediately before the damage or destruction occurred if necessary for the structure to comply with applicable State or Federal requirements.
- (b) Any reconstruction shall commence within 12 months of the date of damage or destruction, unless an extension is granted by the Planning & Zoning Committee.

**9.07 NONCONFORMING LOTS**

- (1) **DEVELOPMENT PERMITTED.** A nonconforming lot may be developed and used for any use permitted in the district in which the lot is located.
- (2) **LAND DIVISION.** A nonconforming lot shall not be reconfigured or divided which would increase the degree of nonconformity(ies).

## **SECTION 10 ADMINISTRATION**

### **10.01 ORGANIZATION**

- (1) The administration and enforcement of this Ordinance is hereby vested in offices of the Town as follows:
  - (a) Building Inspector/Zoning Administrator
  - (b) Town Planning Commission
  - (c) Board of Appeals
  - (d) Board of Supervisors

### **10.02 BUILDING INSPECTOR/ZONING ADMINISTRATOR**

- (1) The Building Inspector/Zoning Administrator and such deputies or assistants that have been, or shall be, duly appointed by the Town Board is hereby designated as the administrative and enforcement officer for the provisions of this Ordinance.
- (2) DUTIES AND POWERS. The Building Inspector/Zoning Administrator shall possess the following duties and powers:
  - (a) Interpret, administer, and enforce this Ordinance as a representative of the Town.
  - (b) Maintain records of this Ordinance including, but not limited to maps, amendments, conditional uses, variances, appeals, applications, permits, and certificates.
  - (c) Provide to the public the necessary permit application forms and variance and appeals forms. Assist the public in preparing permit applications and variance and appeal petitions.
  - (d) Conduct inspection of buildings, structures, and uses of land to determine compliance with the terms of this Ordinance.
  - (e) Issue or deny all zoning permits, as necessary.
  - (f) Issue or deny all certificates of occupancy, as necessary.
  - (g) Issue or deny all sign permits, as necessary.
  - (h) Issue or deny all wrecking permits, as necessary.

- (i) Suspend or revoke permits/certificates and/or issue cease and desist orders upon noncompliance with the terms of the permit/certificate and/or this Ordinance.
- (j) Investigate all alleged violations of this Ordinance and give notice of all violations of this Ordinance to the owner, resident, agent, or occupant of the premises.
- (k) Report uncorrected violations to the Town Attorney and assist the Town Attorney in the prosecution of ordinance violations.
- (l) Access premises and structures during reasonable hours to make those inspections as deemed necessary by him to ensure compliance with this Ordinance. If, however, the Building Inspector/Zoning Administrator is refused entry after presentation of his identification, he may procure a special inspection warrant in accordance with Chapter 66.122, Wis. Stats.
- (m) Forward to the Town Planning Commission all applications for conditional uses and for amendments to this Ordinance.
- (n) Forward to the Board of Appeals all applications for appeals, variances, and other matters on which the Board of Appeals is required to pass under this Ordinance.
- (o) Attend meetings of the Planning and Zoning Committee, Town Board, and Town Zoning Board of Appeals on an as-needed basis.
- (p) Assist in giving all legal notices required by State Statutes or this Ordinance.
- (q) Recommend to the Planning and Zoning Committee any amendments necessary to make the operation of this Ordinance more effective.
- (r) Make referrals and recommendations to the Planning and Zoning Committee and Town Board in accordance with this Ordinance.

### **10.03 TOWN PLANNING AND ZONING COMMITTEE**

- (1) The Planning and Zoning Committee, as defined herein and as established in Chapter 62.23, Wis. Stats., is the Planning and Zoning Committee referred to in this Ordinance.
- (2) MEMBERSHIP. The Planning and Zoning Committee shall consist of five (5) members of which one (1) may be a Town Board member and four (4) citizen members, who are not otherwise Town officials. Planning and Zoning Committee

members shall be appointed by the Town Chairman and confirmed by the Town Board.

- (a) Terms. Terms shall be for staggered three-year periods.
  - (b) Chairman. Chairman shall be designated by the Town Board Chairman.
  - (c) Alternates. One alternate member shall be appointed by the Town Board Chairman for a term of three years and shall act only when a regular member is absent or refuses to vote due to conflict of interest.
  - (d) Secretary. Secretary shall be the Town Clerk or a Planning and Zoning Committee member appointed by the Planning and Zoning Committee Chairman.
  - (e) Staff. The Building Inspector/Zoning Administrator and any other staff or Town officers shall attend all meetings for the purpose of providing technical assistance when requested by the Commission.
  - (f) Oaths of Office. Official Oaths shall be taken by all members in accordance with Chapter 19.01 and 60.31, Wis. Stats., within five (5) days of receiving notice of their appointment.
  - (g) Vacancies. Vacancies shall be filled for the unexpired term in the same manner as appointments for a full term.
- (3) DUTIES AND POWERS. The Planning and Zoning Committee shall discharge the following duties under this Ordinance:
- (a) Hear all applications for conditional uses and amendments to this Ordinance and report said findings and recommendations to the Town Board in the manner prescribed in this Section for Amendments and Conditional Uses;
  - (b) Prepare and recommend to the Town Board for adoption of a Comprehensive Plan for the Town, and from time to time to recommend amendments as it may deem appropriate.
  - (c) Be enabled to promote Town planning.
  - (d) Make reports and recommendations, per §62.23(4), Wis. Stats., relating to the plan and development of the Town to the Town Board, other public bodies, citizens, public utilities and organizations.
  - (e) Receive from the Zoning Administrator their recommendations as related to the effectiveness of this Ordinance and report its conclusions and recommendations to the Town Board not less frequently than once a year.



- (f) For itself, its members and employees, in the performance of their duties, enter upon land, make examinations and surveys, and place and maintain necessary monuments and marks thereon. However, entry shall not be made upon private land, except to the extent that the private land is held open to the general public, without the permission of the landowner or tenant. If such permission has been refused, entry shall be made under the authority of an inspection warrant issued for cause under §66.0119, Wis. Stats., or other court-issued warrant.
- (g) To hear and decide all other matters as delegated by the Town Board.

#### **10.04 BOARD OF APPEALS**

- (1) The Board of Appeals, as defined herein and as established in Chapter 62.23, Wis. Stats., is the Board of Appeals referred to in this Ordinance.
- (2) MEMBERSHIP. The Board of Appeals shall consist of five members appointed by the Town Chairman and confirmed by the Town Board.
  - (a) Terms. Terms shall be for staggered three-year periods.
  - (b) Chairman. Chairman shall be designated by the Town Chairman.
  - (c) Alternates. One alternate member shall be appointed by the Town Board Chairman for a term of three years and shall act only when a regular member is absent or refuses to vote due to conflict of interest.
  - (d) Secretary. Secretary shall be the Town Clerk or a Planning and Zoning Committee member appointed by the Planning and Zoning Committee Chairman.
  - (e) Staff. The Building Inspector/Zoning Administrator and any other staff or Town officers shall attend all meetings for the purpose of providing technical assistance when requested by the Board.
  - (f) Oaths of Office. Official Oaths shall be taken by all members in accordance with Chapter 19.01 and 60.31, Wis. Stats., within five (5) days of receiving notice of their appointment.
  - (g) Vacancies. Vacancies shall be filled for the unexpired term in the same manner as appointments for a full term.

- (3) DUTIES AND POWERS. The Board of Appeals shall have the following powers:
- (a) Appeals. To hear and decide appeals when it is alleged there is error in any order, requirement, decision, or determination made by an administrative official in the enforcement of this Ordinance.
  - (b) Variances. To hear and decide applications for variance from the terms of this Ordinance as will not be contrary to the public interest, where, owing to special conditions, a literal enforcement will result in unnecessary hardship. The spirit and purposes of this Ordinance shall be observed and the public safety, welfare, and justice secured. Use variances shall not be granted.
- (4) REVIEW BY COURT OF RECORD. Any person or persons aggrieved by any decision of the Board of Appeals may present to the court of record a petition duly verified setting forth that such decision is illegal and specifying the grounds of the illegality. Such petition shall be presented to the court within 30 days after the filing of the decision in the office of the Board of Appeals.

## **SECTION 11 PROCEDURES AND ENFORCEMENT**

### **11.01 ZONING PERMITS**

- (1) **APPLICABILITY.** Unless specifically exempted in this Ordinance, zoning permits, certifying that any use, structure, or site complies with the provisions of this Ordinance shall be required in the following instances:
  - (a) Construction, reconstruction, location, relocation, erection, extension, enlargement, conversion, or structural alteration of any building, structure, or part thereof, except:
    - 1) Signs; However, many types of signs require a sign permit. Refer to Section 7, Signs.
    - 2) Structures which are less than six (6) inches in height above preconstruction grade elevation.
  - (b) Establishment or expansion of any accessory or principal use, except uses permitted as conditional uses.
- (2) **APPLICATIONS.**
  - (a) Every application for a zoning permit shall be submitted to the Zoning Administrator on forms furnished by the Town of Ringle and shall include the following information:
    - 1) Names and Addresses. Names and addresses of the applicant, owner of the site, architect, professional engineer, contractor,
    - 2) Signature of the property owner or agent.
    - 3) Tax parcel number, deed, legal description or other identifier of the subject property.
    - 4) Statement concerning the proposed structure or use of the site.
    - 5) An accurate site plan, drawn at a scale which produces a clearly legible drawing, showing the following:
      - a) Boundaries, dimensions, and area of the subject site.
      - b) The spatial relationship of the subject site to abutting public roads and rights-of-way, private roads, easements, and navigable waters.

- c) The location and dimensions of any existing or proposed structures or additions and their relationship to abutting public roads and rights-of-way, private roads, property lines, existing and proposed wells and sanitary waste disposal systems, and the ordinary high water mark of navigable waters.
      - d) Location of proposed or existing road access points, parking and loading areas, and driveways.
    - 6) Building plans including all floor plans and at least 2 elevation views.
    - 7) Additional information as may be required by the Zoning Administrator in order to determine the full compliance with the requirements of this Ordinance.
    - 8) Water supply and sewage disposal. Satisfactory evidence that a safe and adequate supply of water and approved sewage disposal facilities will be provided shall be submitted.
  - (b) Fee. All permit applications shall be accompanied by a fee established by the Town of Ringle Board of Supervisors. Any costs associated with a third-party consultant hired by the Town for review of an application (e.g., engineering, architectural, legal, etc.) may be the responsibility of the applicant.
  - (c) No application shall be accepted by the Zoning Administrator until complete as judged by the Zoning Administrator and until all fees established by the Town of Ringle have been paid in full. Submittal of a complete application and required application fee does not guarantee approval/issuance of the permit, certificate, or request.
- (3) PERMIT ISSUANCE OR DENIAL.
- (a) Upon the Zoning Administrator's determination that the proposed use or structure complies with the provisions of this Ordinance, a zoning permit shall be issued.
  - (b) The permit shall authorize the applicant to proceed subject to all provisions of the Ordinance and any conditions attached to the permit.
  - (c) An application for a use or structure not in conformity with the provisions of this Ordinance shall be denied a zoning permit and the reasons for denial shall be stated.
  - (d) No permit shall be issued for uses or structures involving human occupancy without documentation that provision has been made for safe and adequate water supply and disposal of sewage.

(4) EXPIRATION.

- (a) Zoning Permits to establish a use shall expire 12 months from date of issuance if no action has commenced to establish the use. Any change of land use after the expiration of a zoning permit shall be considered a violation of this Ordinance.
- (b) Except as sub.(5) applies, regular zoning permits for construction of a structure shall expire 12 months from the date of issuance. Any exterior construction after the expiration of a zoning permit shall be considered a violation of this Ordinance

(5) RENEWAL.

- (a) If construction has commenced prior to the expiration of a regular zoning permit, but is not completed prior to such expiration, a 12 month renewal regular zoning permit shall be issued by the Zoning Administrator upon submittal of a renewal application and fee. Additional renewals shall be granted by the Zoning Administrator upon a finding that progress had been made during the previous year toward completion of the structure. If a 12 month period passes without evidence of progress towards completion, the Zoning Administrator shall advise the Planning & Zoning Committee of same and the Planning & Zoning Committee may call a public hearing on the matter and may impose a completion schedule.
- (6) BUILDING PERMITS REQUIRED. In addition to a zoning permit, a building permit may be required as per the Wisconsin Uniform Dwelling Code and Commercial Building Code.

**11.02 OCCUPANCY CERTIFICATES**

(1) APPLICABILITY.

- (a) No building, or addition thereto, constructed after the effective date of this Ordinance, and no addition to a previously existing building shall be occupied, and no land, vacant on the effective date of this Ordinance, shall be used for any purpose until a certificate of occupancy has been issued by the Building Inspector/Zoning Administrator.
- (b) No change in a use, other than that of a permitted use to another similar permitted use, shall be made until a certificate of occupancy has been issued by the Building Inspector/Zoning Administrator.

- (2) Every certificate of occupancy shall state that the use or occupancy complies with the provisions of this Ordinance.
- (3) APPLICATION FOR OCCUPANCY CERTIFICATE. Every application for a zoning permit shall be deemed to be an application for an occupancy certificate. Submittal of a complete application and required application fee does not guarantee approval/issuance of the permit, certificate, or request.
- (4) ISSUANCE OF OCCUPANCY CERTIFICATE.
  - (a) No occupancy certificate for a building, or portion thereof, constructed after the effective date of this Ordinance, shall be issued until construction has been completed and the premises inspected and certified by the Building Inspector/Zoning Administrator to be in conformity with the plans and specifications upon which the zoning permit was based.
  - (b) Pending the issuance of a regular certificate, a temporary certificate may be issued to be valid for a period not to exceed six (6) months from its date during the completion of any addition or during partial occupancy of the premises.
  - (c) The occupancy certificate shall be issued or written notice shall be given to the applicant stating the reasons why a certificate cannot be issued, not later than 14 days after the Building Inspector/Zoning Administrator is notified in writing that the building or premises is ready for occupancy.
  - (d) Upon written request from the owner, the Building Inspector/Zoning Administrator shall issue an occupancy certificate for any building or premises existing at the time of adoption of this Ordinance certifying, after inspection, the extent and kind of use made of the building or premises and whether or not such use conforms to the applicable provisions of this Ordinance.

### **11.03 CONDITIONAL USE PERMITS**

- (1) APPLICABILITY.
  - (a) A conditional use permit shall be required for the establishment of each use listed as a conditional use in Sec. 2.05 of this Ordinance.
  - (b) A conditional use permit shall be required for the siting and construction of any new mobile service support structure and facilities and class 1 collocations as described in Section 8 of this Ordinance.

- (c) Expansions, changes to, or substitution of conditional uses shall be subject to review and approval by the Planning and Zoning Committee in accordance with this Section.
- (d) Expansion of a use permitted as a conditional use shall require a conditional use permit, except that the minor expansion of a building housing a use permitted as a conditional use which will not increase the scale or intensity of that use and will not increase the floor area of that building shall only require a zoning permit.

(2) APPLICATION

- (a) Application. Applications for Conditional Use Permits shall be made to the Zoning Administrator on forms furnished by the Town of Ringle. The application shall contain facts and information, other than merely personal preferences or speculation, directly pertaining to the conditions and requirements relating to the conditional use, including the required information and plans as indicated on the application form furnished by the Town of Ringle.
- (b) Fee. All permit applications shall be accompanied by a fee established by the Town of Ringle Board of Supervisors. Any costs associated with a third-party consultant hired by the Town for review of an application (e.g., engineering, architectural, legal, etc.) may be the responsibility of the applicant.
- (c) No application shall be accepted by the Zoning Administrator until complete as judged by the Zoning Administrator and until all fees established by the Town of Ringle have been paid in full. Submittal of a complete application and required application fee does not guarantee approval/issuance of the permit, certificate, or request.

- (3) PUBLIC HEARING. A public hearing shall be held by the Planning and Zoning Committee after a Class 2 public notice has been given. The public hearing shall occur at a regularly scheduled Planning and Zoning Committee meeting within 45 days after receipt of a complete application, unless the time is extended by agreement with the applicant. At the public hearing, any party may appear in person or by agent or attorney. The applicant has the burden of proof and must demonstrate that the application and all requirements and conditions established by the town relating to the conditional use are or shall be satisfied, both of which must be supported by substantial evidence.

(4) REVIEW AND APPROVAL

(a) Review and Approval.

- 1) The Planning and Zoning Committee and Town Board shall review the site plans, landscape plans, existing and proposed structures, architectural plans, neighboring uses, parking areas, driveway locations, highway access, traffic generation and circulation, drainage, sewerage and water systems, and the proposed operation.
- 2) The Planning and Zoning Committee, within thirty (30) days of the public hearing, make a report and recommendation of approval or denial of the Conditional Use Permit with any conditions it may deem appropriate to the Town Board, unless the time is extended by agreement with the applicant. In making its decision, the Planning and Zoning Committee shall keep written record of findings relative to the standards for considering a Conditional Use application.
- 3) The Town Board shall, within thirty (30) days of Planning and Zoning Committee action, act to approve or deny the Conditional Use Permit, unless the time is extended by agreement with the applicant. If an application for a conditional use permit is not acted upon finally by the Town Board within thirty (30) days of Planning and Zoning Committee action, the conditional use permit shall be deemed to have been approved, unless the time is extended by agreement with the applicant.
- 4) The Planning and Zoning Committee and Town Board action/decision to approve or deny the conditional use permit must be supported by substantial evidence.
- 5) An applicant's failure to demonstrate, by substantial evidence, that the application and all applicable requirements in this Ordinance and conditions established by the town relating to the conditional use are or will be satisfied shall be grounds to deny the conditional use permit. At all times the burden of proof to demonstrate satisfaction of these criteria remains with the applicant.
- 6) If the application is denied, the reasons for denial shall be stated in the decision.

(b) Basis of Approval or Denial

- 1) The Planning and Zoning Committee and Town Board shall review each conditional use permit application for compliance with all requirements applicable to that specific use and to all other relevant provisions of this Ordinance. The Planning and Zoning Committee and Town Board



action/decision to approve or deny the conditional use permit must be supported by substantial evidence.

- 2) To aid in the review and decision-making regarding the proposed conditional use, the Planning and Zoning Committee and Town Board shall evaluate the following specific criteria, as applicable, but shall not be limited thereto:
  - a) The establishment, maintenance, or operation of the conditional use will not be detrimental to or endanger the health, safety, and general welfare of the Town and of the immediate area in which such use would be located.
  - b) The conditional use will not be injurious to the use and enjoyment of other property in the immediate vicinity nor adversely affect property values in the area.
  - c) The establishment of the conditional use will not impede the normal and orderly development and improvement of the surround property for uses allowed in the district.
  - d) Adequate utilities, access, drainage, and/or other necessary facilities have been or are being provided.
  - e) Adequate measures have been or will be taken to provide ingress and egress and the proposed project will not adversely affect traffic flow and congestion on public streets.
  - f) The conditional use is consistent with the Town of Ringle Comprehensive Plan or any other officially adopted town plan.
  - g) The conditional use conforms to the applicable regulations of the district in which it is located.

(c) Conditions.

- 1) The Town Board may, in approving an application for a conditional use permit, impose such conditions and requirements that it determines are required to prevent or minimize adverse effects from the proposed conditional use on other properties in the neighborhood and on the general health, safety, and welfare of the Town
- 2) All such conditions placed on a Conditional Use shall be:
  - a) Consistent with the general purpose or intent of this Ordinance.

- b) Based upon substantial evidence, defined as facts and information other than merely personal preferences or speculation, directly pertaining to the requirements and conditions an applicant must meet to obtain a Conditional Use Permit and that reasonable persons would accept in support of a conclusion; and
- c) Measurable, to the extent practical.

(5) EXPIRATION, DURATION, AND TRANSFER

- (a) Expiration. All conditional use permits shall expire 12 months from the date of authorization by the Town Board where the Town Board determines that no action has commenced to establish the authorized use.
- (b) Duration. A conditional use permit will generally remain in effect as long as the conditions and requirements upon which the permit was issued are followed. The Town Board may, at its discretion, grant a limited term conditional use permit if a reasonable basis exists for such limitation. Any limited term conditional use permit may be subject to renewal after a re-evaluation of the use via a public hearing before the Planning and Zoning Committee and approval by the Town Board.
- (c) Transfer. Subsequent owners of the property are generally allowed to continue the use, subject to conditions and requirements imposed on the original conditional use permit.

- (6) REVOCATION OF CONDITIONAL USE PERMIT. Should a permit applicant, his heirs or assigns, fail to comply with the conditions of the permit issued by the Town Board or should the use, or characteristics of the use be changed without prior approval by the Town Board, the Conditional Use Permit may be revoked. The process for revoking a permit shall generally follow the procedures for granting a permit as set forth in this Ordinance.

**11.04 SIGN PERMITS**

Refer to Section 7, Signs, for Sign Permit requirements and procedures.

**11.05 WRECKING PERMITS**

- (1) PURPOSE. To orderly maintain records of the removal of structures within the Town, ensure proper disposal of demolition materials, ensure proper abandonment of private on-site wastewater treatment systems (POWTS) and private wells, and to provide technical assistance to property owners.

(2) APPLICABILITY. Wrecking permits shall be required in the following instances:

(a) Wrecking, demolition, razing, or removal of any principal or accessory building, structure, or part thereof, except:

1) Structures which are less than six (6) inches in height above preconstruction grade elevation.

(3) APPLICATIONS.

(a) Every application for a wrecking permit shall be submitted to the Zoning Administrator on forms furnished by the Town of Ringle and shall include the following information:

1) Names and Addresses. Names and addresses of the applicant, property owner, and contractor.

2) Signature of the applicant and property owner or agent.

3) Address, tax parcel number, deed, legal description or other identifier of the subject property.

4) Date in which the demolition will occur and time period of demolition.

5) An accurate site plan which produces a clearly legible drawing, showing the building(s), structure(s), or part(s) thereof being wrecked, demolished, razed, or removed:

6) Verification that:

a) All utilities having service connections with the building or structure of the work to be done will be notified.

b) All connections such as meters and regulators will be removed or sealed and plugged in a safe manner.

c) All rubble, rubbish, and other debris from any work or construction site will be removed promptly so as to safeguard against health, safety, and welfare of the public.

d) All rubble, rubbish, and other debris will be hauled to a site that is either a licensed solid waste disposal facility or will otherwise allow the deposit of such materials under all state, county, and town laws, ordinances, and regulations.

7) A description of how the site will be reclaimed.

- 8) Additional information as may be required by the Zoning Administrator in order to determine the full compliance with the requirements of this Ordinance.
  - (b) Fee. All permit applications shall be accompanied by a fee established by the Town of Ringle Board of Supervisors. Any costs associated with a third-party consultant hired by the Town for review of an application (e.g., engineering, architectural, legal, etc.) may be the responsibility of the applicant.
  - (c) No application shall be accepted by the Zoning Administrator until complete as judged by the Zoning Administrator and until all fees established by the Town of Ringle have been paid in full. Submittal of a complete application and required application fee does not guarantee approval/issuance of the permit, certificate, or request.
- (4) PERMIT ISSUANCE OR DENIAL.
- (a) Upon the Zoning Administrator's determination that the proposed wrecking, demolition, razing, or removal of building(s), structure(s), or part(s) thereof complies with the provisions of this Ordinance, a wrecking permit shall be issued.
  - (b) The permit shall authorize the applicant to proceed subject to all provisions of the Ordinance and any conditions attached to the permit.
- (5) EXPIRATION.
- (a) Wrecking permits shall expire 12 months from date of issuance if no action has commenced wreck, demolish, raze, or remove the building, structure or part thereof.
- (6) MARATHON COUNTY PERMIT REQUIRED. In addition to a wrecking permit from the Town, a Marathon County Demolition Permit may be required to be obtained per the Marathon County Shoreland, Shoreland-Wetland, and Floodplain Code.

## **11.06 AMENDMENTS**

- (1) APPLICABILITY. The Town Board may, from time to time on its own motion or on petition, amend, supplement or change this Ordinance, including the Official Zoning Map.

(2) INITIATION OF AMENDMENT. Amendments may be proposed by the Town Board, the Planning and Zoning Committee or by any interested person or organization.

(3) ZONING TEXT AMENDMENT APPLICATION

(a) All applications for proposed text amendments to this Ordinance, shall be made to the Zoning Administrator. The complete application shall be comprised of all of the following:

- 1) Existing Ordinance Text: A copy of the portion of the current ordinance which is proposed to be amended;
- 2) Proposed Ordinance Text: A copy of the proposed amendment;
- 3) Written Justifications: As an optional requirement, the applicant may wish to provide written justification for the proposed text amendment, consisting of the reasons why the applicant believes the proposed text amendment is in harmony with the Town of Ringle Comprehensive Plan and the purpose of this Ordinance.

(b) Fee. All permit applications shall be accompanied by a fee established by the Town of Ringle Board of Supervisors. Any costs associated with a third-party consultant hired by the Town for review of an application (e.g., engineering, architectural, legal, etc.) may be the responsibility of the applicant.

(c) No application shall be accepted by the Zoning Administrator until complete as judged by the Zoning Administrator and until all fees established by the Town of Ringle have been paid in full. Submittal of a complete application and required application fee does not guarantee approval/issuance of the permit, certificate, or request.

(4) ZONING MAP AMENDMENT APPLICATION

(a) All applications for proposed amendments to the Official Zoning Map, shall be made to the Town Zoning Administrator. The complete application shall be comprised of all of the following:

- 1) Map of Property: A map of the subject property showing all lands for which the zoning is proposed to be amended, and all other lands within 200 feet of the boundaries of the subject property, together with the names and addresses of the owners of all lands on said map as the same appear on the current tax records of the Town of Ringle. The map shall clearly indicate the current zoning of the subject property and all property on the map. The map shall be at a scale, which is not less than one inch equals

800 feet. All lot dimensions of the subject property, graphics scale, and a north arrow shall be provided;

- 2) **Location Map:** A map, such as the Future Land Use Plan Map, of the generalized location of the subject property in relation to the Town as a whole.
  - 3) **Written Justifications:** As an optional requirement, the applicant may wish to provide written justification for the proposed amendment consisting of the reasons why the applicant believes the proposed Official Map amendment is in harmony with the Town of Ringle Comprehensive Plan and the purpose of this Ordinance.
- (b) **Fee.** All permit applications shall be accompanied by a fee established by the Town of Ringle Board of Supervisors. Any costs associated with a third-party consultant hired by the Town for review of an application (e.g., engineering, architectural, legal, etc.) may be the responsibility of the applicant.
- (c) No application shall be accepted by the Zoning Administrator until complete as judged by the Zoning Administrator and until all fees established by the Town of Ringle have been paid in full. Submittal of a complete application and required application fee does not guarantee approval/issuance of the permit, certificate, or request.
- (5) **PUBLIC HEARING.** A public hearing shall be held by the Planning and Zoning Committee on each application for an amendment after a Class 2 public notice has been given. The public hearing shall occur at a regularly scheduled Planning and Zoning Committee meeting within 45 days after receipt of a complete application, unless the time is extended by agreement with the applicant. The hearing shall be conducted and a record of such proceedings shall be preserved in such manner as the Planning and Zoning Committee shall by rule prescribe from time to time.
- (6) **NOTIFICATION TO MARATHON COUNTY AND ADJOINING MUNICIPALITY.** Not less than 10 days before the hearing, a copy of the notice shall be provided to the office of the Marathon County Zoning Administrator and the clerk of any municipality whose boundaries are within 1,000 feet of any lands included in the proposed amendment. Failure to give such notice shall not invalidate such amendment.
- (7) **FINDINGS OF FACT AND RECOMMENDATION OF THE PLANNING AND ZONING COMMITTEE.**
- (a) Within 30 days after the close of the hearing on a proposed amendment, the Planning and Zoning Committee shall make written findings of fact and shall submit same together with its recommendations to the Town Board, unless the time is extended by agreement with the applicant. Where the purpose and

effect of the proposed amendment is to change the zoning classification of particular property, the Planning and Zoning Committee shall make findings based upon the evidence presented to it in each specific case with respect to the following matters:

- 1) Existing use of property within the general area of the property in question.
  - 2) The zoning classification of property within the general area of the property in question.
  - 3) The suitability of the property in question to the uses permitted under the existing zoning classifications.
  - 4) The trend of development, if any, in the general area of the property in question, including changes if any which have taken place since the day the property in question was placed in its present zoning classification.
- (b) The Planning and Zoning Committee shall not recommend the adoption of a proposed amendment unless it finds that the adoption of such amendment is consistent with the adopted comprehensive plan and is in the public interest.
- (8) ACTION BY THE TOWN BOARD.
- (a) The Town Board shall not act upon a proposed amendment to this Ordinance until it shall have received a written report and recommendation from the Planning and Zoning Committee on the proposed amendment.
  - (b) The Town Board may grant or deny any application for an amendment, provided however, that in the event of a written protest against any proposed amendment, signed and acknowledged by the owners of 20 percent or more either of the areas of the land included in such proposed amendment, or by the owners of 20 percent or more of the area of the land immediately adjacent extending 100 feet therefrom, or by the owners of 20 percent or more of the area of the land directly opposite thereto extending 100 feet from the street frontage of such opposite land, such amendment shall not be granted except by a favorable vote of majority of all the members of the Town Board.
  - (c) If an application for a proposed amendment is not acted upon finally by the Town Board within 90 days of the date upon which such application and recommendations are received by the Town Board from the Planning and Zoning Committee, it shall be deemed to have been approved, unless the time is extended by agreement with the applicant.
  - (d) No proposed amendment shall be approved or denied if such decision is inconsistent with the adopted comprehensive plan.

## 11.07 VARIANCES

- (1) The Board of Appeals, after a public hearing, may determine and vary the regulations of this Ordinance in harmony with their general purpose and intent, only in specific instances hereinafter set forth, where the Board of Appeals makes findings of fact in accordance with the standards hereinafter prescribed and further, finds that there are practical difficulties or particular hardships in the way of carrying out the strict letter of the regulations of this Ordinance.
- (2) APPLICATION AND NOTICE OF HEARING.
  - (a) An application for a variance shall be filed with the Zoning Administrator using forms furnished by the Town of Ringle. Such application shall include the following:
    - 1) Name and address of the property owner and petitioner (if different).
    - 2) Signature of petitioner.
    - 3) Location of property involved in the petition.
    - 4) Proposed use or structure in question, including a site plan showing the preferred arrangement for which the variance is sought.
    - 5) Section(s) of this Ordinance from which a variance is requested.
    - 6) Details as to the narrowness, shallowness, shape, topography, or other characteristics of the land or the physical conditions applying to the building, structure, use or intended use which make it not merely inconvenient but extremely difficult, if not impossible, to comply with the provisions of the Ordinance.
    - 7) A statement that the conditions detailed above are unique to this property and are not generally existing on other properties in the same zoning district.
    - 8) A statement that the unnecessary hardship was not caused by the applicant nor by any persons still having an interest in the property.
  - (b) Fee. All permit applications shall be accompanied by a fee established by the Town of Ringle Board of Supervisors. Any costs associated with a third-party consultant hired by the Town for review of an application (e.g., engineering, architectural, legal, etc.) may be the responsibility of the applicant.



- (c) No application shall be accepted by the Zoning Administrator until complete as judged by the Zoning Administrator and until all fees established by the Town of Ringle have been paid in full. Submittal of a complete application and required application fee does not guarantee approval/issuance of the permit, certificate, or request.
- (3) PUBLIC HEARING. A public hearing shall be held by the Board of Appeals on each application for a variance after a Class 2 public notice due notice to the parties in interest has been given. The public hearing shall occur at a regularly scheduled Board of Appeals meeting within 45 days after receipt of a complete application, unless the time is extended by agreement with the applicant. At the public hearing, any party may appear in person or by agent or attorney. The applicant has the burden of proof and must demonstrate that the application satisfies all findings outlined in Sec. 11.07(4) of this Ordinance. The hearing shall be conducted and a record of such proceedings shall be preserved in such manner as the Board of Appeals shall by rule prescribe from time to time.
- (4) FINDINGS. No variance to the provisions of this Ordinance shall be granted by the Board unless it finds by the preponderance of evidence presented that all the following facts and conditions exist and so indicates such in the minutes of its proceedings. The burden of proof, at all times, remains with the applicant to establish that the proposed variance satisfies the following findings:
  - (a) Preservation of Intent. No variance shall be granted that is not consistent with the purpose and intent of the regulations for the District in which the development is located. No variance shall have the effect of permitting a use in any District that is not a stated Permitted Use or Conditional Use in that particular District.
  - (b) Unnecessary Hardship. No variance shall be granted unless compliance with the provisions of this Ordinance cause an unnecessary hardship. Unnecessary hardship exists when compliance would unreasonably prevent the owner from using the property for a permitted purpose (leaving the property owner without any use that is permitted for the property) or would render conformity with such restrictions “unnecessarily burdensome”.
  - (c) Unique Property Limitations. No variance shall be granted unless there are unique physical limitations of the lot or parcel that do not apply generally to other properties in the same District and the granting of the variance would not be of so general or recurrent nature as to suggest that this Ordinance should be changed.
  - (d) No Harm to Public Interest. No variance shall be granted that will create substantial detriment to adjacent property and will materially impair or be contrary to the purpose and spirit of this Ordinance or the public interest.

- (e) Economic Hardship and Self-Imposed Hardship. No variance shall be granted solely on the basis of economic gain or loss. Self-imposed hardships shall not be considered as grounds for the granting of a variance.
  - (f) Preservation of Property Rights. The variance must be necessary for the preservation and enjoyment of substantial property rights possessed by other properties in the same District and same vicinity.
- (5) DECISION. The Board of Appeals shall decide all appeals and applications within 30 days after the final hearing and shall transmit a signed copy of the Board's decision to the appellant or applicant, Zoning Administrator, Building Inspector, Planning and Zoning Committee, and Town Board, unless the time is extended by agreement with the applicant.
- (6) REVIEW BY COURT OF RECORD. Any person or persons aggrieved by any decision of the Board of Appeals may present to the court of record a petition duly verified setting forth that such decision is illegal and specifying the grounds of the illegality. Such petition shall be presented to the court within 30 days after the filing of the decision in the office of the Board of Appeals.

## **11.08 APPEALS**

- (1) Appeals concerning the literal enforcement of this Ordinance may be made by any person aggrieved or by any officer, department, board, or bureau of the Town. Such appeals shall be filed with the Zoning Administrator within 30 days after the date of written notice of the decision or order of the Zoning Administrator. Applications may be made by the owner or lessee of the structure, land, or water to be affected at any time and shall be filed with the Zoning Administrator. Such appeals and applications shall include the following:
- (a) Name and Address of the appellant or applicant and all abutting and opposite property owners of record.
  - (b) Plat of Survey prepared by a registered land surveyor.
  - (c) Additional Information as may be required by the Board of Appeals.
- (2) FEE. All permit applications shall be accompanied by a fee established by the Town of Ringle Board of Supervisors. Any costs associated with a third-party consultant hired by the Town for review of an application (e.g., engineering, architectural, legal, etc.) may be the responsibility of the applicant. Submittal of a complete application and required application fee does not guarantee approval/issuance of the permit, certificate, or request.

- (3) **PUBLIC HEARING.** A public hearing shall be held by the Board of Appeals on each appeal after a Class 2 public notice due notice to the parties in interest has been given. The public hearing shall occur at a regularly scheduled Board of Appeals meeting within 45 days after receipt of an appeal, unless the time is extended by agreement with the applicant. At the public hearing, any party may appear in person or by agent or attorney. The hearing shall be conducted and a record of such proceedings shall be preserved in such manner as the Board of Appeals shall by rule prescribe from time to time.
- (4) **DECISION.** The Board of Appeals shall decide all appeals and applications within 30 days after the final hearing and shall transmit a signed copy of the Board's decision to the appellant or applicant, Zoning Administrator, Building Inspector, Planning and Zoning Committee, and Town Board, unless the time is extended by agreement with the applicant.
- (5) **REVIEW BY COURT OF RECORD.** Any person or persons aggrieved by any decision of the Board of Appeals may present to the court of record a petition duly verified setting forth that such decision is illegal and specifying the grounds of the illegality. Such petition shall be presented to the court within 30 days after the filing of the decision in the office of the Board of Appeals.

**11.09 PUBLIC HEARINGS.** When public hearings are required by this Ordinance or by Wisconsin Statutes, the following shall apply:

- (1) **NOTICE FOR PUBLIC HEARINGS.**
  - (a) Notice of any public hearing which the Planning and Zoning Committee or Board of Appeals is required to hold shall be given by publishing a Class 2 notice in accordance with Ch. 985, Wis. Stats. The notice shall specify the time and place of such hearing.
  - (b) If the public hearing involves a petition for a zoning amendment, a copy of the notice shall be provided to the office of the Marathon County Zoning Administrator and the clerk of any municipality whose boundaries are within 1,000 feet of any lands included in the proposed amendment. Failure to give such notice shall not invalidate such amendment.
  - (c) If the public hearing involves a variance or an appeal before the Board of Appeals, the Board of Appeals shall also give due notice to the parties in interest.

Commentary: As a matter of practice, in addition to the parties identified in pars. (b) and (c), an earnest effort will be made to give due notice to the applicant or their agent and to the property owners (as recorded in the Marathon County Real Property Listing Office) of all lands located within 300

feet of any part of the parcel or parcels included in the conditional use permit application, zoning amendment application, variance application, or appeal. The failure to mail a notice to the above parties or the failure of such notice to reach any of the above parties does not invalidate any public hearing nor any decision of the Planning and Zoning Committee or Board of Appeals.

- (2) PUBLIC HEARING PROCEDURES. The Town Board may adopt any formal or informal public hearing procedures.
- (3) SPECIAL MEETINGS. An applicant for a conditional use, zoning amendment, variance, or appeal may request a special meeting by the Planning and Zoning Committee or Board of Appeals to review and/or conduct a public hearing on said application. The decision to grant a request for a special meeting shall be at the sole discretion of the chairperson of the Planning and Zoning Committee or Board of Appeals, as applicable. All fees and costs associated with holding the special meeting and conducting the public hearing, including any public hearing notice publication costs, shall be the responsibility of the applicant and shall be paid in full by applicant at least one (1) week prior to the special meeting.

#### **11.10 FEE SCHEDULE**

- (1) PUBLISHING. Fees for zoning permits, occupancy certificates, conditional uses, sign permits, wrecking permits, zoning amendments, variances, appeals, or other requests before the Town shall be required to defray the cost of administration, map preparation, inspections, public notices, and record keeping. The Town Board shall, upon recommendation of the Planning and Zoning Committee, establish a Fee Schedule by resolution, and the Fee Schedule shall be published and made available through the Town Clerk. The said Fee Schedule may be updated from time to time upon recommendation of the Planning and Zoning Committee and by resolution of the Town Board.
- (2) DOUBLE FEES. A double fee shall be charged by the Town if work is started before a permit is applied for and issued. Such double fee shall not release the applicant from full compliance with this Ordinance, nor from prosecution for violation of this Ordinance.
- (3) THIRD-PARTY CONSULTATION/ASSISTANCE. Any costs associated with a third-party consultant hired by the Town for review of an application (e.g., engineering, architectural, legal, etc.) may be the responsibility of the applicant.

## **11.11 PENALTIES**

- (1) Any person, firm, or corporation, or agent, employee, or contractor of such, who violates, disobeys, omits, neglects, or refuses to comply with, or who resists enforcement of any provision of this Ordinance, shall, upon conviction, forfeit not less than \$50.00 nor more than \$500.00 for each offense, together with the costs of prosecution, and in default of payment of such forfeiture and costs of prosecution shall be imprisoned in the County Jail of Marathon County until said forfeiture and costs are paid, but not to exceed 30 days for each violation. Each day that a violation continues to exist shall constitute a separate offense.

## SECTION 12 DEFINITIONS

### 12.01 DEFINITIONS

- (1) For the purpose of this Ordinance, certain words or phrases shall have meanings that either vary somewhat from their customary dictionary meanings or are intended to be interpreted to have a specific meaning.
  - (a) Words used in the present tense in this Ordinance include the future.
- (2) The word "person" includes a firm, association, partnership, trust, company, or corporation as well as an individual.
- (3) The word "shall" is mandatory, the word "should" is advisory, and the word "may" is permissive.
- (4) Any words not defined in this Ordinance shall be presumed to have their customary dictionary definitions.
- (5) Definitions relating to signs are located in Sec. 7.13 of this Ordinance.

### 12.02 WORDS AND PHRASES DEFINED

- (1) The following words, phrases, and terms whenever they occur in this Ordinance, shall be interpreted as herein defined.

**Accessory Dwelling Unit:** A residential dwelling unit located on the same lot as a “Single-Family Detached Residence”, either as part of the same building as the “Single-Family Detached Residence” or in a detached building. An accessory dwelling unit shall include permanent provisions for living, sleeping, eating, cooking, and sanitation.

**Accessory Residence:** Residential dwelling unit or units accessory to a nonresidential use on the same lot or building site that provide(s) living quarters for the owner, proprietor, commercial tenant, employee, or caretaker of the nonresidential use.

**Accessory Structure:** A structure which is incidental or subordinate to the principal structure on the same parcel, and may be desirable but not necessary for the use of the parcel as permitted by this Code.

**Accessory Use:** A use customarily incident and accessory to the principal use of a lot or parcel, or building or structure on the same lot or parcel as the principal use.

**Active Outdoor Public Recreation:** All outdoor land uses located on public property or public easement that accommodates active recreational activities. Such land uses include play courts (such as tennis courts and basketball courts), playfields (such as ball diamonds, football fields,

and soccer fields), tot lots, outdoor swimming pools, swimming beach areas, fitness courses, golf courses open to the public, and similar land uses.

**Adult Entertainment/Adult-Oriented Establishment:** Any exhibition of any motion pictures, live performance, display or dance of any type, which has as its dominant theme, or is distinguished or characterized by an emphasis on, any actual or simulated specific sexual activities or specified anatomical areas, or the removal of articles of clothing to appear totally nude or to display a nude genital area or female nude breasts. Also, an adult bookstore having as its stock in trade, for sale, rent, lease, inspection or viewing, books, films, videocassettes, CDs, SD cards, flash drives, internet connection, magazines or other periodicals that are distinguished or characterized by their emphasis on matters depicting, describing or relating to specific sexual activities or specific anatomical areas, and in conjunction therewith have facilities for the presentation of adult-oriented films, movies or live performances, for observation by patrons.

**Agriculture:** Any of the following activities conducted for the purpose of producing an income, livelihood, or for purposes related to any type of hobby farm:

- Crop or forage production
- Keeping farm animals/livestock
- Beekeeping
- Nursery, sod, or Christmas tree production
- Maple syrup production
- Floriculture
- Aquaculture
- Fur farming
- Forest management
- Enrolling land in a federal agricultural commodity payment program or a federal or state agricultural land and conservation payment program.

Also includes an activity that is an integral part of, or incidental to, an agricultural use. Such use shall not entail on-site retail sales or services.

**Agricultural-Related Use:** A facility, whether or not located on a farm, that has at least one of the following as a primary and not merely incidental purpose:

- Providing agricultural supplies, agricultural equipment, agricultural inputs, or agricultural services directly to farms
- Storing, processing, or handling raw agricultural commodities obtained directly from farms
- Slaughtering livestock, including seasonal processing of wild game such as deer and bear, provided such facility does not exceed 20,000 square feet in total floor area.
- Marketing livestock to or from farms
- Processing agricultural by-products or wastes received directly from farms.
- Agri-tourism

Examples of such uses include, but are not limited to, agricultural implement sales, storage, and/or repair operations; feed and seed stores; agricultural chemical dealers and/or storage facilities; animal feed storage facilities (except those accessory to an agricultural use); commercial dairies; food processing facilities; licensed farm auction operations; canning and

other food packaging facilities; wineries/breweries/distilleries in which the agricultural products used for production are grown primarily on the site or on an adjacent property in common ownership; greenhouses and garden centers; orchard stores; agricultural waste and by-product disposal facilities (except those accessory to an “Agricultural Use”); farms regularly open for tours, demonstrations, hayrides, corn mazes, farm breakfasts, and other similar events; sawmills; de-barking operations; chipping facilities; and livestock veterinary clinics. Not included within this land use category are plants intended to convert agricultural products to energy on a large-scale basis, Sales of Farm and Forestry Products, landscape contractors, and/or any other separately listed land use.

**Airport:** Any area of land or water which is used or intended for use for the landing and taking off of aircraft, and any appurtenant areas which are used or intended for airport buildings or other airport facilities or rights-of-way, including all necessary taxiways, aircraft storage and tie-down areas, hangars, and other necessary buildings and open spaces.

**Alley:** A public or private right-of-way primarily designed to serve as secondary access to the side or rear of those properties whose principal frontage is on a street.

**Alteration:** A change or rearrangement in the structural parts of a structure, an enlargement of a structure, whether by extending on the side or by increasing the height, or the movement of a structure from one location to another.

**Animal Shelters/Pounds:** A place and/or building, or portion thereof, that is used for the keeping and rehabilitation of lost or abandoned household animals for future re-homing.

**Artisan Gallery/Studio:** A building or portion thereof used for the preparation, display, and sale of individually crafted artwork, photography, jewelry, furniture, sculpture, pottery, leathercraft, hand-woven sections, and related items.

**Asphalt/Concrete Plant:** A permanent establishment devoted to the mixing and/or preparation of asphalt or concrete for construction project off-site.

**Bakery:** An establishment in which baked goods are made for wholesale or retail sale. A bakery may include retail sale and display of products produced on-site.

**Basement:** That portion of a building the floor-line of which is below lot grade and the ceiling of which is not more than five feet above lot grade.

**Board of Appeals:** Means a body designated by the legislative body to hear appeals from land-use decisions and variances from the terms of this Ordinance.

**Boardinghouse:** Any place of lodging, other than a hotel or motel, where sleeping accommodations are offered, with or without meals, for compensation for 5 or more non-tourist or non-transient persons, but not exceeding 20 persons.



**Building:** Any structure for the shelter, support or enclosure of persons, animals, chattels or property of any kind.

**Building, Accessory:** A subordinate or supplemental building, the use of which is incidental to that of the principal building on the same lot or incidental to the use of the premises on which it is located.

**Building, Principal:** A non-accessory building used for the protection of goods or chattels in which a principal use of the premises on which it is located is conducted.

**Building Height:** The vertical distance from the average grade to the highest point of the coping of a flat roof or to the deck line of a mansard roof, or to the mean height level between eaves and ridges for gable, hip, and gambrel roofs.

**Bulk Storage of Fuel Products:** An establishment in which large quantities of liquid or gaseous fuel is stored, which may include storage for the purpose of wholesale or retail sale.

**Campground:** Any parcel or tract of land, owned by a person, the state, or a local government, which is used for the purpose of providing campsites for non-permanent overnight use by four or more camping units or for non-permanent overnight use by one to three camping units if the parcel or tract of land is represented as a campground. Note: Represented as a campground means to advertise using media, a sign, or a symbol.

**Camping:** The use of any parcel or tract of land for the purpose of temporary overnight sleeping accommodations.

**Cemetery:** A place and/or building, or portion thereof, which is used or is intended for burial purposes. Accessory uses include columbariums, crematories, mausoleums, and mortuaries when operated in conjunction with and within the boundaries of such area.

**Class 2 Public Notice:** The publication of a legal notice in a newspaper likely to give notice in the area or to the person affected, requiring two (2) insertions which must be published once each week for consecutive weeks, the last of which shall be at least one week before the act or event, unless otherwise specified by law. (See Chapter 985, Wis. Stats.)

**Closed Construction:** Any building, building component, assembly or system manufactured in such a manner that it cannot be inspected before installation at the building site without disassembly, damage or destruction. (See §101.71(1), Wis. Stats.)

**Club:** An association for some common purpose, but not including a group organized for or which is actually engaged in rendering a service which is customarily carried on as a business. A roadhouse or tavern shall not be construed as a club.

**Commercial Radio/TV Broadcast Studio:** A place and/or building, or portion thereof, in which broadcast studios and offices related to commercial radio/TV broadcasts are located.

**Commercial Riding Stable:** Any establishment where horses are kept for commercial riding or recreation. This term includes establishments in which the boarding of horses and/or riding opportunities are provided for compensation or a fee.

**Commercial Storage Facility:** A place and/or building, or portion thereof, that is divided into individual spaces and that is used or is intended as individual storage units that are rented, leased, or owned. The term includes a tract of land used to store vehicles, campers, boats, and the like that are not for sale or trade.

**Commercial Trucking Establishment:** A place and/or building, or portion thereof, which is used or is intended for storage of freight for routing or reshipment.

**Community Garden:** An area for cultivation and related activities divided into one or more plots to be cultivated by more than two operators or members, as a principal land use of a property. The Community Garden may be the sole principal use of the property or may be a second principal use on a property. Does not include personal gardens for cultivation of crops for home consumption on the site or on an adjacent property in common ownership as the personal residence.

**Community Living Arrangement:** A place and/or building, or portion thereof, that is used for community living arrangements for adults, as defined in Wis. Stats. § 46.03(22); community living arrangements for children, as defined in Wis. Stats. § 48.743(1); foster homes, as defined in Wis. Stats. § 48.02(6); or adult family homes, as defined in Wis. Stats. § 50.01 (1) (a) or (b).

- Community Living Arrangement for Adults per Wis. Stats. § 46.03(22): *A community-based residential facility, as defined in s. 50.01 (1g).*
  - Community-Based Residential Facility per s. 50.01 (1g): *A place where 5 or more adults who are not related to the operator or administrator and who do not require care above intermediate level nursing care reside and receive care, treatment or services that are above the level of room and board but that include no more than 3 hours of nursing care per week per resident.*
- Foster Homes per Wis. Stats. § 48.02(6): *Any facility that is operated by a person required to be licensed by s. 48.62 (1) and that provides care and maintenance for no more than 4 children or, if necessary to enable a sibling group to remain together, for no more than 6 children or, if the department promulgates rules permitting a different number of children, for the number of children permitted under those rules.*
- Adult Family Homes per Wis. Stats. § 50.01 (1) (a) or (b):
  - (a) *A private residence to which all of the following apply:*
    1. *Care and maintenance above the level of room and board but not including nursing care are provided in the private residence by the care provider whose primary domicile is this residence for 3 or 4 adults, or more adults if all of the adults are siblings, each of whom has a developmental disability, as defined in s. 51.01 (5), or, if the residence is licensed as a foster home, care and maintenance are provided to children, the combined total of adults and children so served being no more than 4, or more adults or children if all of the adults or all of the children are siblings.*

2. *The private residence was licensed under s. 48.62 as a home for the care of the adults specified in subd. 1. at least 12 months before any of the adults attained 18 years of age.*
- (b) *A place where 3 or 4 adults who are not related to the operator reside and receive care, treatment or services that are above the level of room and board and that may include up to 7 hours per week of nursing care per resident.*

**Conditional Use:** A use allowed under a conditional use permit. Specifically, a use whose nature, character, or circumstance is so unique or so dependent upon specific conditions that predetermination of permissibility by right is not practical, but which may be permitted on a case-by-case basis subject to the conditional use permit procedure

**Contractor Storage Yard:** An establishment which is used for the storage of construction vehicles, equipment, and materials for contractors. This use may include ancillary professional offices, showrooms, and workspaces. Examples include plumbers, heating and air conditioning contractors, excavators, carpenters, painting contractors, wastewater treatment system contractors, electricians, well drillers, and similar uses.

**Development:** Any artificial change to improved or unimproved real estate, including, but not limited to, the construction of buildings, structures or accessory structures; the construction of additions or substantial improvements to buildings, structures or accessory structures; the placement of building or structures; mining, dredging, filling, grading, paving, excavation or drilling operations; and the storage, deposition or extraction of materials, public or private sewerage disposal systems or water supply facilities.

**District:** A designated area of the Town for which the regulations governing the use of the land and buildings are uniform.

**Duplex:** See Two Family Residence.

**Dwelling:** A structure, or portion thereof, which is used or intended to be used as residential living quarters.

**Family:** One or more persons each related to the other by blood, marriage, or adoption, who are living together in a single dwelling and maintaining a common household. A family includes any domestic servants and not more than one gratuitous guest residing with said family.

**Family Day Care Home:** A dwelling licensed as a day care center by the Wisconsin Department of Health and Family Services where care is provided for not more than eight (8) children. (See §66.1017, Wis. Stats.)

**Farm:** An area of land devoted to the production of field or truck crops, livestock or livestock products, which constitute the major use of such property. This includes fur farms in which the animals are housed and fed under artificial conditions.

**Feedlot:** A feedlot shall be determined to be any of the following facilities, when they are a business and means of livelihood:

- (1) Any tract of land or structure wherein any type of fowl or the byproducts thereof are raised in close quarters for sale at wholesale or retail.
- (2) Any structure, pen, or corral wherein cattle, horses, sheep, goats, and swine are maintained in close quarters for the purpose of fattening such livestock for final shipment to market.

**Floor Area:** The gross horizontal areas of the several stories within the outer lines of the exterior walls of a building or from the centerline of party walls; provided that the floor area of a dwelling shall not include space not usable for living quarters, such as attics, utility or unfinished basement rooms, garages, breezeways and unenclosed porches, or terraces.

**Funeral Home:** An establishment, occupied by a professional licensed mortician, with facilities for burial preparation or cremation and funeral services.

**Fur Farm:** Any property comprising land or building or both, used for the purpose of raising or harboring fur bearing animals, including those defined in Chapter 29.627, Wis. Stats., and also including chinchillas and other fur bearing animals, whether the animals are kept for breeding or slaughtering or pelting purposes.

**Gas Station/Carwash:** A place and/or building, or portion thereof, that is used or is intended for the retail sale of gasoline, kerosene, diesel, or other petroleum-based motor fuels. The term includes the sale of convenience foods and goods, provided it is ancillary to the sale of fuels.

**Grade:** The average level of the finished surface of the ground adjacent to the exterior walls of the building or structure.

**Grading:** The physical disturbance of the ground by the addition, removal, or re-distribution of soil.

**Group Day Care Center:** A land use in which licensed persons and facilities provide child care services for nine or more children, such as day care centers, pre-schools, and nursery schools.

**Home Occupation – Major:** A moderate impact economic activity conducted in conjunction with a residence, where the principal use of the lot is the residence of the person conducting the economic activity. See Sec. 3.06(1).

**Home Occupation – Minor:** A low to moderate impact economic activity conducted entirely within a dwelling unit, its attached garage, and/or an accessory building on the same parcel as the dwelling unit, where the principal use of the lot is the residence of the person conducting the economic activity. See Sec. 3.06(1).

**Hotel/Motel:** A building in which board and lodging are provided to the transient public for compensation.

**Implements of Husbandry:** A self-propelled or towed vehicle that is manufactured, designed or reconstructed to be used and that is exclusively used in the conduct of agricultural operations. (See §340.01(24)(a) & (b), Wis. Stats.)

**Improvement:** Any building, structure, place, work of art, or other object constituting the physical betterment of real property, or any part of such betterment, including street grading and surfacing with or without curbs and gutter, sidewalks, crosswalks, water mains, sanitary and storm sewers, culverts, bridges, streets and trees.

**Indoor Commercial Entertainment:** All uses that provide entertainment services entirely within an enclosed building, or where outdoor entertainment facilities are present, the land area of such facilities is not greater than 15 percent of the gross floor area indoors. Indoor Commercial Entertainment uses often have operating hours that extend significantly later than most other commercial land uses. Examples of such land uses include restaurants, brewpubs, taverns, theaters, health or fitness centers, other indoor private recreation centers, training studios (dance, art, martial arts, etc.), bowling alleys, arcades, roller rinks, indoor shooting ranges, pool halls, concert venues and wedding halls.

**Institutional Residential:** A place and/or building, or portion thereof, that is used for senior housing, retirement homes, assisted living facilities, nursing homes, hospices, group homes, convents, monasteries, dormitories, convalescent homes, limited care facilities, rehabilitation centers, and similar land uses not considered to be Community Living Arrangements under Wis. Stats. §62.23.

**Lot:** A continuous parcel of land, not divided by a public right-of-way, occupied or intended to be occupied by a principal structure or use and the accessory structures or uses permitted thereto, and sufficient in size to meet the lot width and lot area provisions of this Ordinance.

**Lot Area:** The area of a horizontal plane bounded by the front, side, and rear lot lines of a lot, but not including the area of any land below the ordinary high water mark of navigable waters.

**Lot Line:** A line bounding a lot which divides one lot from another lot or from a street or road.

**Lot Line, Front:** The lot line nearest to the centerline of the public or private road from which the lot takes access, except that for essentially rectangular lots abutting cul de sacs, the front lot line shall be that lot line which is generally parallel and closest to the centerline of the access road.

**Lot Line, Rear:** In the case of rectangular or most trapezoidal shaped lots, that lot line which is generally parallel to and most distant from the front lot line of the lot. In the case of an irregular or triangular lot, a line 20 feet in length, entirely within the lot, parallel to, and at the maximum possible distance from, the front lot line.

**Lot Line, Side:** Any lot line other than a front or rear lot line.

**Lot of Record:** Any lot, the description of which is properly recorded with the Marathon County Register of Deeds, which at the time of its recordation complied with all applicable laws, ordinances, and regulations.

**Lot Width:** The shortest distance between side lot lines, measured at/through both of the following locations:

- (1) At the intersection of the side lot lines with the public road right-of-way or private road easement; and
- (2) Through the midpoint of the lot. The midpoint of the lot shall be the midpoint of the shortest line that can be drawn between the front lot line and the rear lot line.

**Kennel, Type I:** Any place or dwelling wherein or whereon more than two (2) dogs over the age of 6 months are kept or housed. This term does not include commercial kennels, boarding kennels, dog motels, dog training establishments, veterinary clinics/animal hospitals, animal grooming establishments, or pet shops.

**Kennel, Type II:** Any place, dwelling, or establishment wherein or whereon more than two (2) dogs over the age of 6 months are kept for breeding, sale, or sporting purposes, or where boarding care is provided for compensation. This term includes commercial kennels, boarding kennels, dog motels, and dog training establishments. This term does not include veterinary clinics/animal hospitals, animal grooming establishments, or pet shops.

**Library/Museum:** A place in which literary, musical, artistic, or reference materials (such as books, manuscripts, recordings, or films) are kept for use but not for sale; or an institution devoted to the procurement, care, study, and display of objects of lasting interest or value.

**Living Quarters:** A building or a portion of a building which provides, as a minimum, an area equipped or furnished for sleeping purposes, or those finished portions of a building in which normal residential activities occur.

**Lumber/Building Supply Yard:** A place and/or building, or portion thereof, used or is intended for wholesale or retail sales of bulk construction materials such as roofing, lumber, bricks, component parts (trusses) and the like. The term does not include hardware stores, concrete plants, asphalt mixing plants or any facility that manufactures building materials and offers them for retail sale on the premises.

**Major Subdivision:** See “Subdivision, Major”.

**Manufactured Home:** A structure that is designed to be used as a dwelling with or without a permanent foundation and that is certified by the federal department of housing and urban development as complying with the standards established under 42 USC 5401 to 5425. (See § 101.91(2)(am), Wis. Stats.)

**Manufactured Home Community:** Any plot or plots of ground upon which 3 or more manufactured homes that are occupied for dwelling or sleeping purposes are located. “Manufactured home community” does not include a farm where the occupants of the

manufactured homes are the father, mother, son, daughter, brother or sister of the farm owner or operator or where the occupants of the manufactured homes work on the farm. (See §101.91(5m), Wis. Stats.)

**Manufacturing, Assembly, Processing:** An industrial establishment in which the primary purpose is for manufacturing, assembly, and/or processing of raw materials or individual parts by hand or machinery for the purpose of wholesale distribution.

**Minor Subdivision:** See “Subdivision, Minor”.

**Mobile Communication Tower:** An existing or new structure that supports or can support a mobile service facility or radio/TV broadcast facility, including a mobile service support structure, utility pole, water tower, building, or other structure.

**Mobile Home:** A vehicle manufactured or assembled before June 15, 1976, designed to be towed as a single unit or in sections upon a highway by a motor vehicle and equipped and used, or intended to be used, primarily for human habitation, with walls of rigid uncollapsible construction, which has an overall length in excess of 45 feet. “Mobile home” includes the mobile home structure, its plumbing, heating, air conditioning and electrical systems, and all appliances and all other equipment carrying a manufacturer's warranty. (See §101.91(10), Wis. Stats.)

**Modular Home:** Any structure or component thereof which is intended for use as a dwelling and:

1. Is of closed construction and fabricated or assembled on-site or off-site in manufacturing facilities for installation, connection, or assembly and installation, at the building site; or
2. Is a building of open construction which is made or assembled in manufacturing facilities away from the building site for installation, connection, or assembly and installation, on the building site and for which certification is sought by the manufacturer.

Modular home” does not mean any manufactured home or any building of open construction which is not subject to par. 2 above. (See § 101.71(6), Wis. Stats.)

**Multi-Family Residence:** A single structure with three or more individual attached dwelling units, including “rental apartments,” condominium buildings with 3+ units each, townhouses, and row houses. Each dwelling unit may take access from a shared entrance or hallway or from a private, individual exterior doorway.

**Municipal Building:** A place and/or building, or portion thereof, that is used or is intended for a government office or facility. Examples include Town hall, public works/highway garages, publicly-owned community centers and the like.

**Nonconforming Structure:** Any structure conforming in respect to use but not in respect to frontage, width, height, area, yard, parking, loading, or distance requirements shall be considered a nonconforming structure and not a nonconforming use.

**Nonconforming Use:** Any building or land lawfully occupied by a use at the effective date of this Chapter or amendment thereto which does not conform after the passage of this Chapter or amendment with the use requirements of the district in which it is situated.

**Nonmetallic Mining:** Operations or activities for the extraction from the earth for sale or use by the operator of mineral aggregates such as stone, sand, gravel and nonmetallic minerals such as asbestos, beryl, clay, feldspar, peat, talc; topsoil and related processes such as crushing, screening, scalping, dewatering and blending.

**Noxious Matter:** Material which is capable of causing injury to living organisms by chemical reaction or is capable of causing detrimental effects upon the physical or economic wellbeing of individuals. This may include, but is not limited to asbestos, silicon, silica, radon, fumes, odor, smoke, chemicals, fuel, oil, lead, solvents, waste, and hazardous substances.

**Occupancy Certificate:** An official written document, issued by the Zoning Administrator, which certifies that the use or structure complies with all applicable provisions of this Ordinance and the zoning permit, sign permit, or conditional use permit issued for that use or structure.

**On-Site Agricultural Retail:** The sale of agricultural products grown primarily on the site or on an adjacent property in common ownership, on a year-round basis or requiring the construction and maintenance of permanent structures, except that packaging and equipment used to store, display, package, or carry products for the convenience of the operation or its customers (such as egg cartons, baskets, containers, and bags) may be produced off-site. Includes permanent or seasonal dining establishments, wineries/breweries, and bakeries in which products are grown, processed, prepared, and served on the same farm.

**Open Construction:** Any building, building component, assembly or system manufactured in such a manner that it can be readily inspected at the building site without disassembly, damage or destruction. (See § 101.71(7), Wis. Stats.)

**Open Fence:** A fence whose entire length is not greater than 50% opaque and whose individual elements or sections are also not greater than 50% opaque.

**Outdoor Commercial Recreation:** All outdoor land uses located on private property that accommodates passive or active recreational activities for a fee. Such land uses include arboretums, natural areas, wildlife areas, hiking trails, bike trails, cross country ski trails, horse trails, open grassed areas, picnic areas, picnic shelters, gardens, fishing areas (including commercial fishing ponds), play courts (such as tennis courts and basketball courts), playfields (such as ball diamonds, football fields, and soccer fields), tot lots, outdoor swimming pools, swimming beach areas, fitness courses, golf courses open to the public, and similar land uses. Not included within this land use category are private conservancy lands restricted against further development and/or any other separately listed land use.

**Outdoor Shooting Range:** Any parcel or tract of land which is designed and operated for the use and discharge of firearms, not within an enclosed building, for compensation, a fee, or membership fee.



**Outdoor Theater:** A place and/or building, or portion thereof, that is used or intended for dramatic performances or the showing of motions pictures outdoors.

**Parking Lot:** A lot where automobiles are parked or stored temporarily, but not including the wrecking of automobile or other vehicles or storage for the purpose of repair or wrecking.

**Passenger Bus Terminal:** Any establishment for the storage or parking of commercial passenger vehicles or where commercial passenger vehicles pick up and discharge fare-paying passengers, with or without accessory business offices.

**Passive Outdoor Public Recreation:** All recreational land uses located on public property or a public easement that involves passive recreational activities. Such land uses include arboretums, natural areas, wildlife areas, hiking trails, bike trails, cross country ski trails, horse trails, open grassed areas not associated with any particular “Active Outdoor Public Recreation” land use, picnic areas, picnic shelters, gardens, fishing areas (not including commercial fishing ponds), and similar land uses. Also includes private conservancy lands restricted against further development.

**Permitted Use:** A use which may be lawfully established in a particular district or districts, provided it conforms with all requirements, regulations, and standards of such district.

**Person:** An individual, or group of individuals, corporation, partnership, association, municipality or state agency.

**Places of Worship:** A place and/or building, or portion thereof that is used or is intended as a place where persons regularly assemble for religious worship and associated activities. The term includes sanctuaries, chapels, cathedrals, churches, mosques, synagogues, and temples and other onsite accessory buildings such as parsonages, friaries, convents, fellowship halls, Sunday schools, and rectories. The term does not include day care centers, community recreation facilities, dormitories, private educational facilities, emergency shelters, health care facilities, and the like.

**Principal Structure:** The primary structure on a parcel of land where the Principal Use occurs.

**Principal Use:** The Permitted Use or Conditional Use that fulfills the primary function the parcel.

**Private Airstrips/Landing Fields:** A facility providing takeoff, landing, and storage for private air transportation vehicles.

**Professional Office/Service Establishment:** Exclusively indoor land uses whose primary function is the provision of services directly to an individual on a walk-in or on-appointment basis. Examples include professional services, banks, insurance or financial services, realty offices, medical offices and clinics, veterinary clinics/animal hospitals, animal grooming establishments, barber shops, and beauty shops.

**Property Lines:** The lines bounding a lot, as defined herein.

**Public/Private Park:** A place and/or building, or portion thereof, that is used or is intended for recreational activities, relaxation, leisure, or ornament, and/or kept in its natural state, and for use by the general public or by a homeowners' association.

**Recreation Camp:** An area containing one or more permanent buildings used occasionally or periodically for the accommodation of members of associations or groups for recreational purposes.

**Retail:** The sale of goods to the public in relatively small quantities for use or consumption rather than for resale.

**Road, Private:** A thoroughfare which affords principle means of access to abutting property, but which has not been dedicated to the public and/or subject to public easements.

**Road, Public:** A thoroughfare which affords principle means of access to an abutting property which has been dedicated to the public and/or subject to public easements.

**Roadside Stand:** The sale of agricultural products grown exclusively on the site or on an adjacent property in common ownership, on a year-round or seasonal basis or requiring the construction and maintenance of permanent structures, except that packaging and equipment used to store, display, package, or carry products for the convenience of the operation or its customers (such as egg cartons, baskets, containers, and bags) may be produced off-site. Not included within this land use category are permanent or seasonal dining establishments, wineries/breweries, and bakeries. The area dedicated to retail sales and display of agricultural products shall not exceed 200 square feet in total floor area.

**Salvage Yard:** Any land or structures used for a salvaging operation including but not limited to the above-ground, outdoor storage and/or sale of waste paper, rags, scrap metal, and any other discarded materials intended for sale or recycling; and/or the collection, dismantlement, storage, or salvage of more than 2 disassembled, unlicensed, inoperable, junked or wrecked motor vehicles, truck bodies, tractors, trailers. Recycling facilities involving on-site outdoor storage of salvage materials are included in this land use.

**School/College/University:** A place and/or building, or portion thereof, which is used or is intended for use as a preschool, elementary, junior high, high school, vocational school, college, or university.

**Setback:** The minimum horizontal distance between the existing or proposed property lines, street, road, or highway to a structure or use.

**Short Term Rental (STR):** A single family residential structure that offers overnight accommodations for a daily fee that also serves as a primary residence of the operator or owner. An STR includes bed & breakfast establishments, rental vacation home by owner or other similar overnight private rental accommodations for fewer than 29 consecutive days.

**Sign Definitions:** See Sec. 7.13 of this Ordinance.

**Single Family Detached Residence:** A detached residential building designed for or occupied exclusively by one family and surrounded by open space or yards and which is not attached to any other dwelling by any means. This term includes modular homes and site-built homes constructed on permanent foundations and which meet the minimum floor area requirements of this Ordinance. This term excludes manufactured homes and mobile homes, except double-wide manufactured homes constructed on permanent foundations and which meet the minimum floor area requirements of this Ordinance are considered single family detached residences.

**Slaughterhouse:** An establishment in which animals are butchered for a fee for wholesale or retail sale (except those permitted as an “Agricultural-Related Use”).

**Social Clubs/Lodges:** A place and/or building, or portion thereof, that is used for the assembly of private, hunting/conservation, or civic clubs or organizations for meetings and special events.

**Solid Waste Facility:** Any use dedicated to the collection, storage, processing, and/or disposal of solid wastes as defined by Wis. Stats. § 289.01(33), organic materials for composting or for off-site energy production, and/or materials for recycling.

**Special Event Venue:** An establishment which caters to the organized assembly of more than 100 individuals at any one time for special events. This use includes uses such as concert and wedding venues and similar events. This term does not include events sponsored by the Town of Ringle. This term does not include a property or establishment in which two (2) or less occasional auctions, weddings, funerals, family reunions, and other similar occasional private events involving the assembly of less than 500 individuals at any one time are held per calendar year. Any event, not sponsored by the Town of Ringle, which caters to the organized assembly of 500 or more individuals shall be considered a Special Event Venue use and shall comply with all applicable requirements of this Ordinance for a Special Event Venue.

**Story:** The vertical distance between the surface of any floor and the floor next above it, or if there be no floor above it, the space between such floor and the ceiling next above it.

**Street:** A public or private thoroughfare which affords a primary means of access to abutting property.

**Structure:** Anything constructed, erected, or manufactured and placed on or in the ground.

**Structural Alterations:** Any change in the supporting members of a structure such as bearing walls, columns, beams or girders, footing, and piles.

**Subdivision, Major:** Any subdivision classified as a County, State, Condominium, Planned Unit Development, or Conservation Plat. *(See Section 18.013.02, General Code of Ordinances for Marathon County Chapter 18 Land Division and Surveying Code)*

**Subdivision, Minor:** Any subdivision classified as a certified survey map where:

- A. The act of division creates not more than 4 lots, outlots, parcels or building sites which are less than 10 acres in size; or
- B. The act of division of an outlot within a recorded subdivision plat into not more than 4 parcels or building sites without changing the original exterior boundaries of such lot or outlot.

*(See Section 18.013.02, General Code of Ordinances for Marathon County Chapter 18 Land Division and Surveying Code)*

**Temporary Asphalt/Concrete Plant:** A temporary establishment devoted to the mixing and/or preparation of asphalt or concrete for construction project on or off-site.

**Temporary or Seasonal Use:** A use which is conducted for a limited period of time within a calendar year.

**Temporary or Seasonal Structure:** A movable structure not designed for human occupancy which may be used for the protection of goods or chattels and which is erected for a limited period of time within a calendar year.

**Two Family Residence (Duplex):** A single structure containing two separate dwelling units, each unit having a private individual exterior access, and with no shared internal access within the building.

**Use:** The purpose or activity for which the land or building thereon is designed, arranged, or intended, or for which it is occupied or maintained.

**Utility Installation-Major:** A place, building and/or structure, or portion thereof, whether public or private, used or is intended for providing basic infrastructure or utility services and which could potentially have moderate to high impact on neighboring property. This term includes energy production and transmission facilities. This term does not include private energy systems (e.g., residential, commercial, & industrial solar energy systems) which produce energy primarily for use on the same lot or parcel as the private energy system is located.

**Utility Installation-Minor:** A utility installation generally having low impact on neighboring property and include no structures above ground.

**Variance:** An authorization, granted by the Board of Appeals, to depart from the literal requirements of this Ordinance. Use variances shall be prohibited.

**Vehicle Sales and Service:** An establishment which is used for the sale, maintenance, service, and/or repair of vehicles.

**Vision Clearance:** A triangular space which permits an unobstructed view at the intersection of highways or streets with other highways, streets or roads or at the intersection of highways or streets with railroads.

**Warehouse/Distribution Center:** A place and/or building, or portion thereof, that is used for the storage of merchandise or commodities for commercial use off-site or wholesale/retail distribution.

**Wastewater Treatment Plant:** An establishment in which sewage is treated with chemical and/or biological means so that it is no longer harmful or dangerous to the environment.

**Winery/Brewery/Distillery:** An establishment where wine, beer, or liquor is produced for wholesale or retail sale. A winery/brewery/distillery may include retail sale and display of products produced on-site.

**Yard:** An open space on a lot which is unoccupied and unobstructed from its lowest level to the sky. A yard extends along a line and at right angles to such lot line to a depth or width specified in the yard regulations for the zoning district in which such lot is located.

**Yard, Front:** A yard extending along the full length of the front lot line between the side lot lines.

**Yard, Rear:** A yard extending along the full length of the rear lot line between the side lot lines.

**Yard, Side:** A yard extending along a side lot line from the front yard to the rear yard.